

# BUSTER + PUNCH

## CAGED WALL 1.0 / LARGE

TECH SPEC



CAGED WALL 1.0 / L  
SATIN BLACK MARBLE

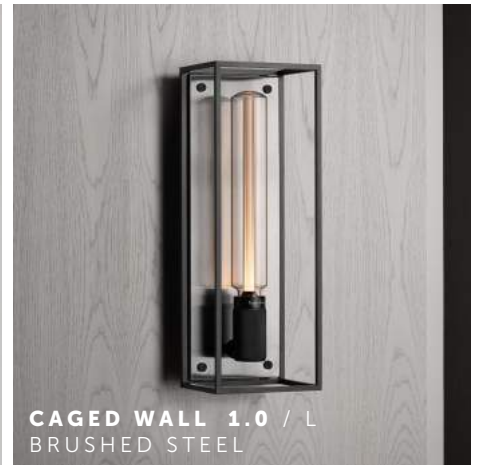

CAGED WALL 1.0 / L  
BRUSHED STEEL

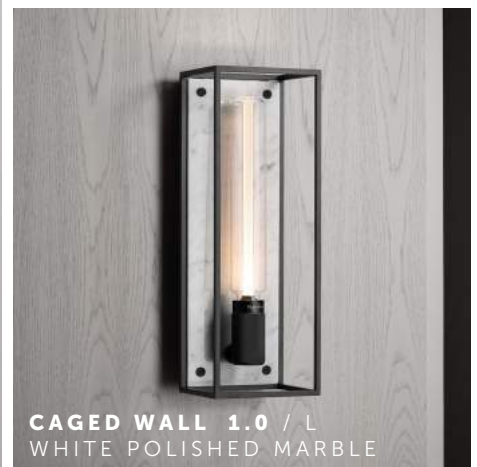

CAGED WALL 1.0 / L  
WHITE POLISHED MARBLE

## CAGED WALL 1.0 / LARGE

CAGED Wall 1.0 / Large perfectly frames the brand new LED BUSTER BULB / TUBE. The wall light is made from a matt black metal cage and comes with a changeable back panel. Caged Wall 1.0 / Large can be displayed on its own, in linear procession or staggered heights for maximum impact.

[busterandpunch.com](http://busterandpunch.com)  
[info@busterandpunch.com](mailto:info@busterandpunch.com)

# BUSTER + PUNCH

## CAGED WALL 1.0 / LARGE

### TECH SPEC



**SPECIFICATIONS:**

E27 screw  
 200-240V  
 IP20  
 Bulb included

**MOUNTING OPTIONS:**

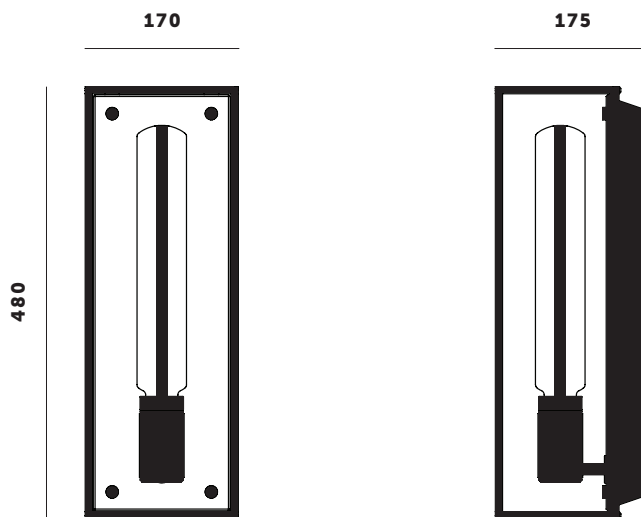
 Wall surface mounted



BACKPLATE FINISH	SKU	LIGHT SOURCE:
 Polished white marble	<b>EU-CGW-L-PWM-A</b>	1 x BUSTER BULB / TUBE included 5W dimmable warm white LED E27 screw 30 000 hrs life
 Brushed steel	<b>EU-CGW-L-BST-A</b>	
 Satin black marble	<b>EU-CGW-L-SBM-A</b>	

**CARE INSTRUCTIONS**

Wipe with damp cloth with no loose hairs, avoid using any chemicals. Please note all finishes are prone to aging.

Make sure you use a plug suitable for your wall material.