

84

A white glass moil is captured inside a fine copper mesh basket and then plunged into hot clear glass. Air is blown into the matrix to gently push the white glass through the mesh, creating a delicate pillowed form that is suspended inside the thick outer layer of clear glass. Sometimes the copper mesh basket folds and crinkles, adding specificity to each piece. Undulations in the exterior shape are a natural consequence of the fabrication process and accentuate the gentle white pillowing below. A low-voltage xenon or LED light source is introduced into the piece, casting a warm coppery hue.

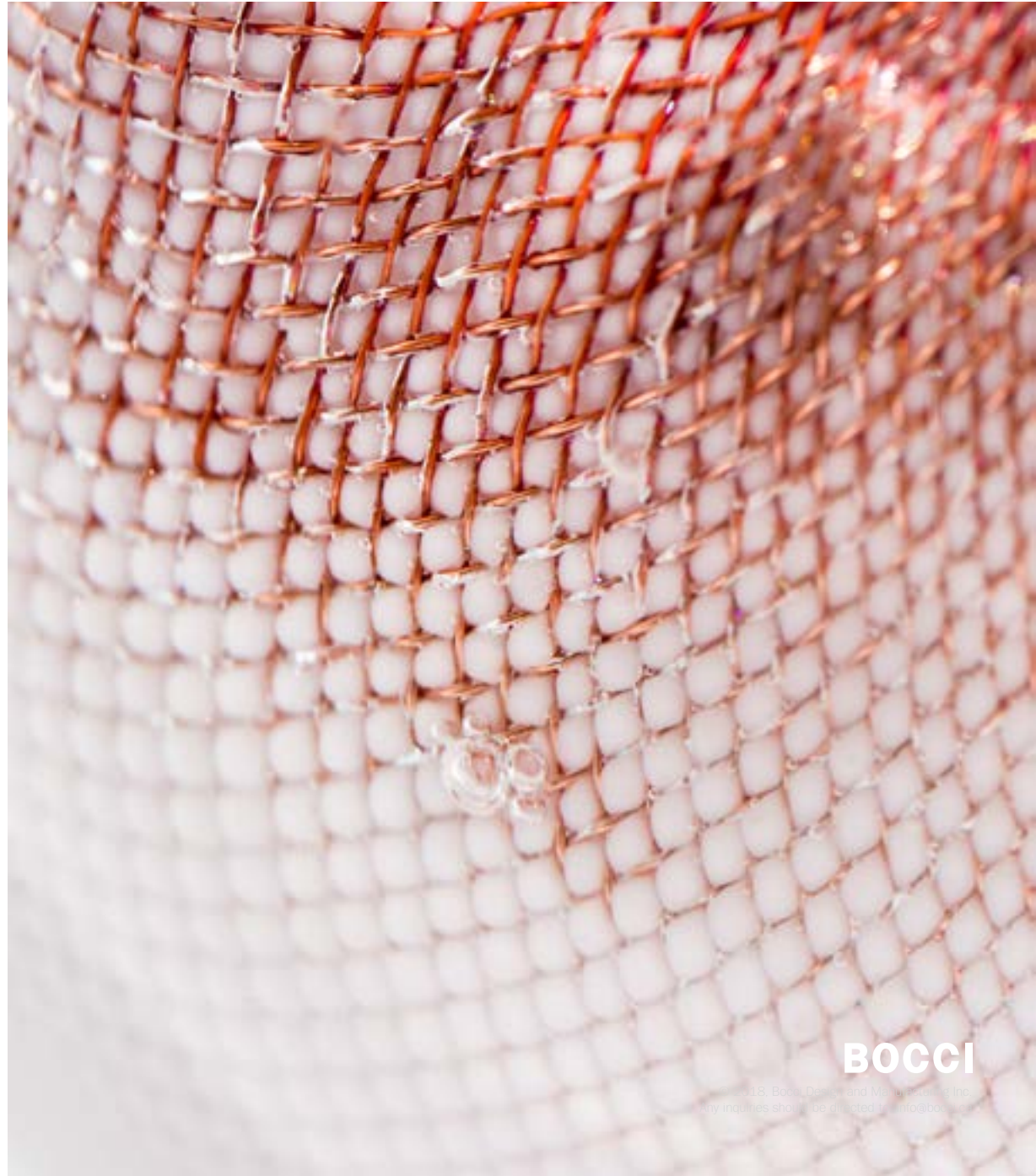

Lamping

1.8w LED or 10w xenon

Material

blown glass, copper mesh, braided metal coaxial cable, electrical components, and white canopy

Patent

US Patent Pending
EU Patent # 003611144-0001 to 0004



84

Surface Mount
Wall/ceiling

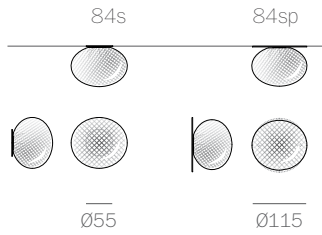

Adjustable
Lengths
Random canopies.

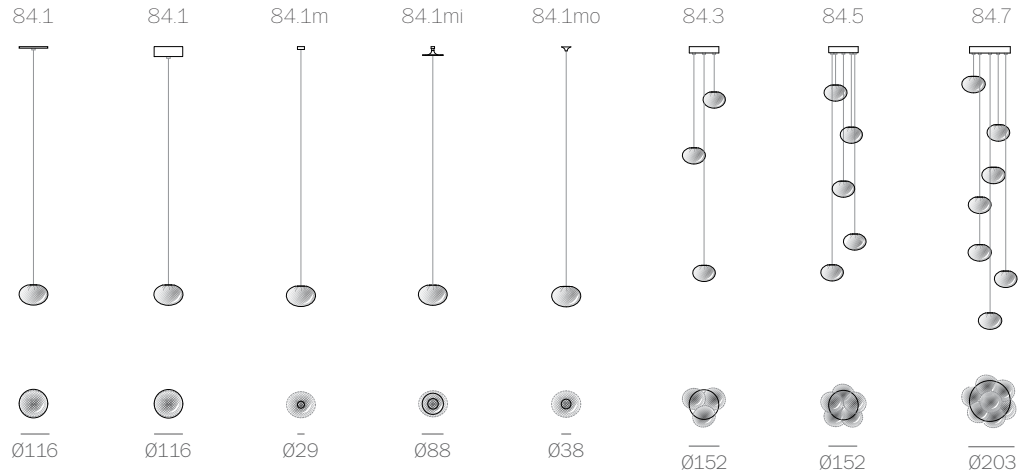

adjustable
up to
3000 (10')
standard

adjustable
up to
30500
(100')
custom

Fixed Lengths
Random canopies.

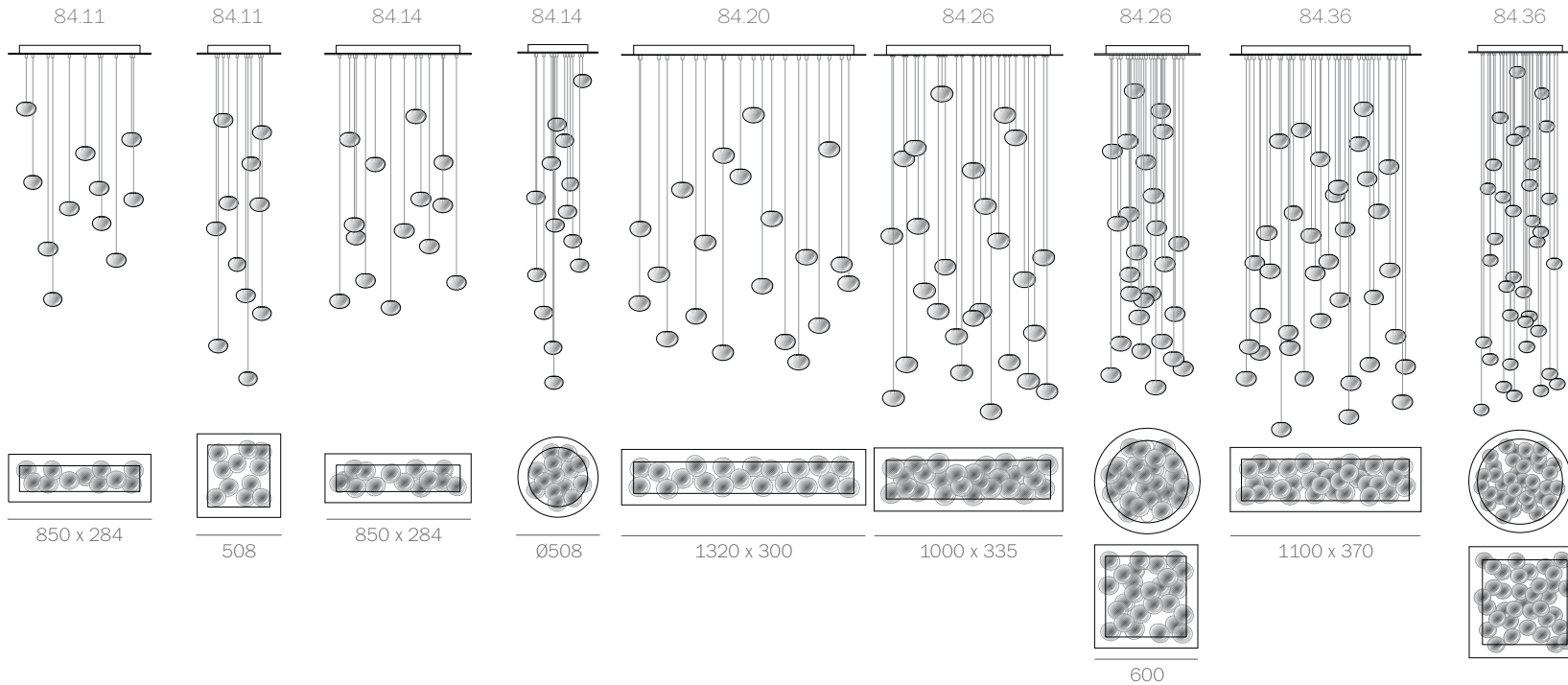

fixed
length
up to
3000 (10')
standard

fixed
length
up to
30500
(100')
custom

755









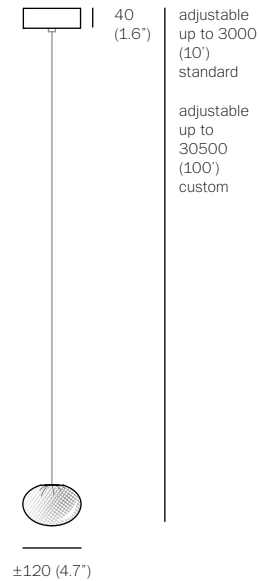

approx 2kg (4.5lb)

- PENDANTS: one
- MOUNTING: deep white canopy 116mm (4.5") in diameter x 40mm (1.6") deep
- LAMPING: 1.8w LED or 10w xenon
- COAX: adjustable. 3000mm (10') standard / up to 30500mm (100') maximum
- MATERIALS: blown glass, copper mesh, braided metal coaxial cable, electrical components, white canopy
- WEIGHT: approximately 2kg (4.5lb)
- TRANSFORMERS: integral. Transformers included

DESCRIPTION

The deep canopy in this 84 variant refers to the canopy size depth capable of accommodating the transformer inside (standard outside of North America and Latin America). The canopy is 116mm (4.5") in diameter and 40mm (1.6") deep. It is designed for surface mounted applications that cannot make use of a junction box or ceiling cavity. The canopy is completely enclosed by a backplate, which houses the transformer. The pendant drop lengths on this light fixture are adjustable up to the specified maximum.

A white glass bubble is captured inside a fine copper mesh basket and then plunged into hot clear glass. Air is blown into the matrix to gently push the white glass through the mesh, creating a delicate pillowed form that is suspended inside the thick outer layer of clear glass. Sometimes the copper mesh basket folds and crinkles, adding specificity to each piece.

NOTES

- + Purchase replacement lamps online at www.bocci.ca/lamps
- + Unless otherwise noted when ordering, all fixtures will be outfitted to be xenon compatible

US Patent Pending
EU Patent # 003611144-0001 to 0004

Made in Vancouver, Canada

Vancouver
sales@bocci.ca
www.bocci.ca

Berlin
europe@bocci.ca
www.bocci.ca

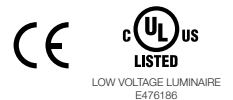

DEEP CANOPY

84.1

Design by Omer Arbel
PRODUCT SPECIFICATION

© 2017, Bocci Design and Manufacturing Inc. All rights reserved. Any inquiries should be directed to: info@bocci.ca

BOCCI

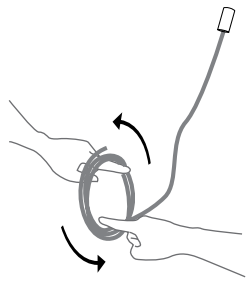

1

Very carefully uncoil the braided coaxial cable in a spool like manner. Insert your index fingers into opposite sides of the roll then rotate your fingers around each other to unroll the coaxial cable.

Use patience: allow the cable to uncoil completely to avoid kinks.

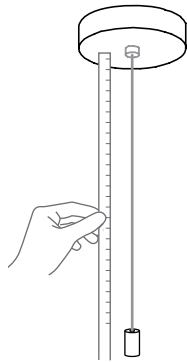

2

Determine the overall drop for the pendant fixture.

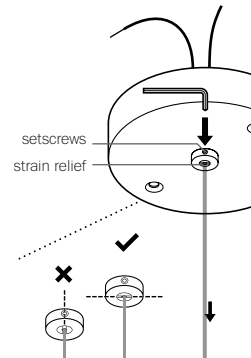

3

Thread the coaxial cable through the canopy, use a 2mm Allen key to loosen the setscrew in the canopy and gently feed the cable through until you have reached your desired drop length.

Use Allen key to tighten the setscrew to hold the strain relief and secure the coaxial cable at its new length. Perform a gentle tug test to ensure it is secure.

DO NOT OVERTIGHTEN.

Note: The strain relief is a black plastic collar around the coaxial cable. There is a single slot opening on the side of the strain relief component. It is essential that this opening is oriented at 90 degrees to set screw chamber. There can be no contact between the set screw and the cable.

RISK OF ELECTRIC SHORT!

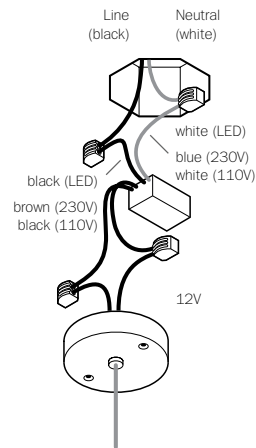

4

Xenon (110V) or LED: connect the black wire to black and white wire to white wire.

Xenon (230V): connect black wire to brown wire and white wire to blue wire.

Connect the coaxial cable to the open slots in the terminal block on the 12V side of the transformers.

For multiple pendant installations, ensure that the braided outer wires are all connected to one 12V output wire and all inner insulated wires are connected to the other or a short will occur.

Once all coaxial connections are made, lift the fixture into position and connect the line voltage to the open slot in the appropriate terminal block.

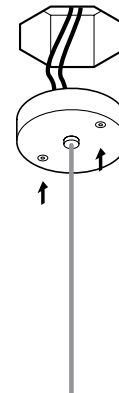

5

The client is responsible to ensure fasteners are attached to a robust structural substrate.

Tuck the transformer and wiring into the canopy. Line up the fastener holes or connect directly to structural ceiling surface using the fasteners provided.

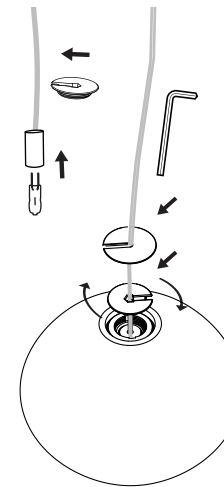

6

Bocci 1.8w LED or 10w xenon lamps are included. Plug the lamp into lamp socket.

Do not touch the lamp with your bare hands.

Remove the centre cap from 84 pendant, sliding it onto the coaxial cable. Gently insert the lamp into the pendant and then tighten the cap connection with the Allen key provided.

DO NOT OVERTIGHTEN.

Slide cover cap onto the coaxial cable and place into the inset portion of the pendant hardware.

Note: when using a dimmer use only low voltage electronic dimmer



7

Clean fingerprints from glass surfaces.

Turn fixture on.

For additional assistance, please contact Bocci:

Vancouver
sales@bocci.ca
www.bocci.ca

Berlin
europe@bocci.ca
www.bocci.ca

US Patent Pending
EU Patent # 003611144-0001
to 0004

Made in Vancouver, Canada



DEEP CANOPY

84.1

Design by Omer Arbel
PRODUCT INSTALLATION INSTRUCTIONS

© 2017, Bocci Design and Manufacturing Inc. All rights reserved. Any inquiries should be directed to: info@bocci.ca

BOCCI

120/240V LED Driver - 4W

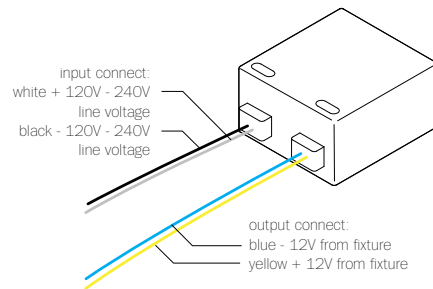

B-L03U-12V

PRIMARY: AC 100 - 240V, 120mA, 50/60Hz

SECONDARY: Max. 12V DC (4.2w max.)

LAMPING: 1w LED lamps: 1-3
1.5w LED lamps: 1-2
1.8w LED lamps: 1-2
2.3w ring LED lamps: 1

DIMMING: Non-dimmable

NOTES: Constant voltage
Class 2 power unit
For LED lamps only

DIMENSION: 43mm (1.7") x 41mm (1.6") x 22mm (0.8")

DESIGNATION:



120/240V LED Driver - 8W

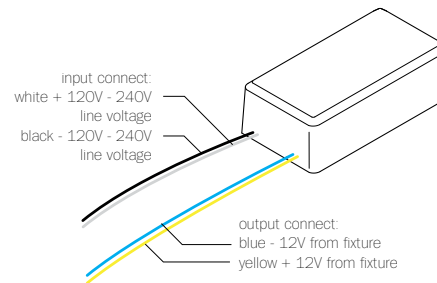

B-L07U-12V

PRIMARY: AC 100 - 240V, 170mA, 50/60Hz

SECONDARY: Max. 12V DC (8.4w max.)

LAMPING: 1w LED lamps: 1-7
1.5w LED lamps: 1-5
1.8w LED lamps: 1-4
2.3w ring LED lamps: 1-3

DIMMING: Non-dimmable

NOTES: Constant voltage
Class 2 power unit
For LED lamps only

DIMENSION: 65mm (2.5") x 35mm (1.3") x 28mm (1.1")

DESIGNATION:

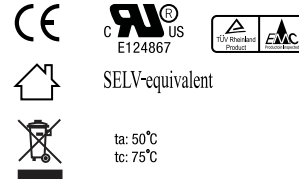

120/240V LED Driver - 24W

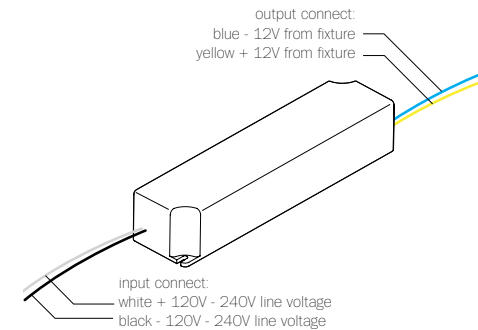

B-L24U-12V

PRIMARY: AC 100 - 240V, 300mA, 60Hz

SECONDARY: Max. 12V DC (24w max.)

LAMPING: 1w LED lamps: 1-24
1.5w LED lamps: 1-16
1.8w LED lamps: 1-13
2.3w ring LED lamps: 1-10

DIMMING: Dimmable using minimum 8 lamps and improves with larger load. Use low voltage electronic dimmers only

NOTES: Short Circuit Protection
Constant voltage
Class 2 power unit
For LED lamps only

DIMENSION: 42mm (1.7") x 170mm (6.7") x 33mm (1.3")

DESIGNATION:



120V Transformer

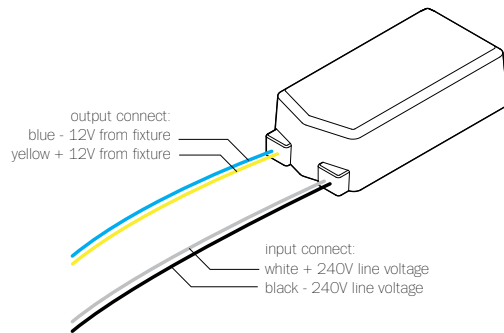

WH-601E6A-3C

PRIMARY: AC 120V 50/60Hz, 500mA

SECONDARY: 12V AC (10w min. - 60w max.)

LAMPING: 10w lamps: 1-6
20w lamps: 1-3

DIMMING: Dimmable using minimum 2 x 10w lamps or 1 x 20w lamp using low voltage electronic and trailing edge dimmers only.

NOTES: Auto stop protected
Class 2 power unit
Electronic transformer for xenon lamps only

DIMENSION: 70mm (2.8") x 36mm (1.4") x 20mm (0.75")

DESIGNATION:   E124867

240V Transformer

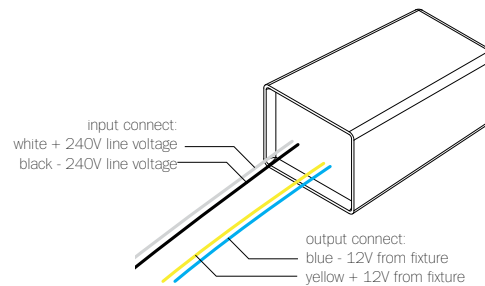

WH-602W

PRIMARY: AC 230V-240V 50Hz, 260mA

SECONDARY: 11.5V AC (10w min. - 60w max.)

LAMPING: 10w lamps: 1-6
20w lamps: 1-3

DIMMING: Dimmable using minimum 2 x 10w lamps or 1 x 20w lamp using low voltage electronic and trailing edge dimmers only.

NOTES: Auto stop protected
Class 2 power unit
Electronic transformer for xenon lamps only

DIMENSION: 63mm (2.5") x 35mm (1.4") x 26mm (1")

DESIGNATION:    

IP65   ta: 50°C
tc: 80°C

240V Transformer

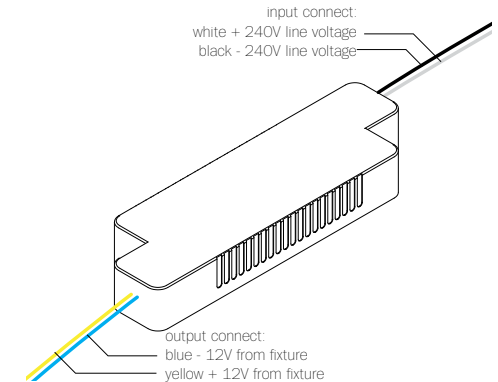

WH-602S

PRIMARY: AC 230V-240V 50Hz, 260mA









SECONDARY: 11.5V AC (10w min. - 60w max.)

LAMPING: 10w lamps: 1-6
20w lamps: 1-3

DIMMING: Dimmable using minimum 2 x 10w lamps or 1 x 20w lamp using low voltage electronic and trailing edge dimmers only.

NOTES: Auto stop protected
Class 2 power unit
Electronic transformer for xenon lamps only

DIMENSION: 117mm (4.5") x 36mm (1.4") x 16mm (0.6")

DESIGNATION:   
   
 

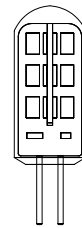
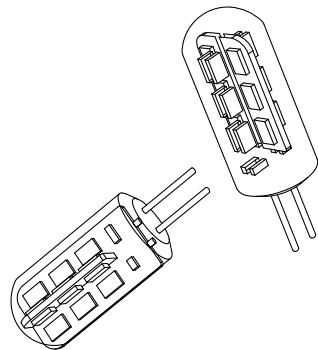
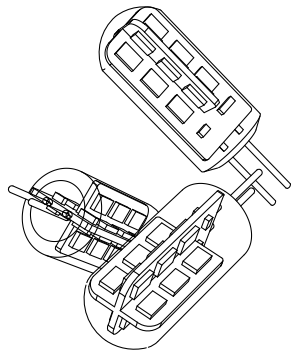
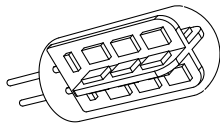
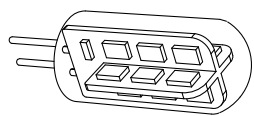

38 (1.5")



12.5 (0.5")

WATTAGE: 1.8w
COLOUR TEMPERATURE: 2600k
CRI: 75 (100 is daylight)
LIGHT OUTPUT: 142 lumens
EFFICIENCY: 60 lm/w
LAMP LIFE: 25,000 hours

DESCRIPTION

The Bocci 1.8w LED lamping option offers a longer-life, energy efficient alternative to typical halogen or xenon lamps. This proprietary and worldwide patent pending design utilizes Bocci's standard G4 lamp holder (9.1mm/0.36" in diameter), which is designed to accept either the Bocci xenon lamp or the Bocci LED lamp. The possibility of dual usage allows the opportunity for existing chandeliers with xenon lamping to be retrofitted on site to LED along with the appropriate driver.

This unique replacement design is unlike typical embedded xenon fixtures as it eliminates the waste associated with catastrophic failures that leave no choice but to replace the entire fixture. When it comes time to relamp, the xenon heads may simply be replaced, as with conventional lamps. Bocci xenon lamp keeps the fixture out of landfills in the future, protects your investment and introduces a significant saving of energy.

NOTES

+ Purchase replacement lamps online at www.bocci.ca/lamps

RoHS 

Vancouver
sales@bocci.ca
www.bocci.ca

Berlin
europe@bocci.ca
www.bocci.ca

LED

1.8W

Design by Omer Arbel
PRODUCT SPECIFICATION

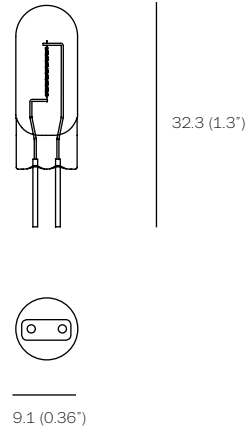
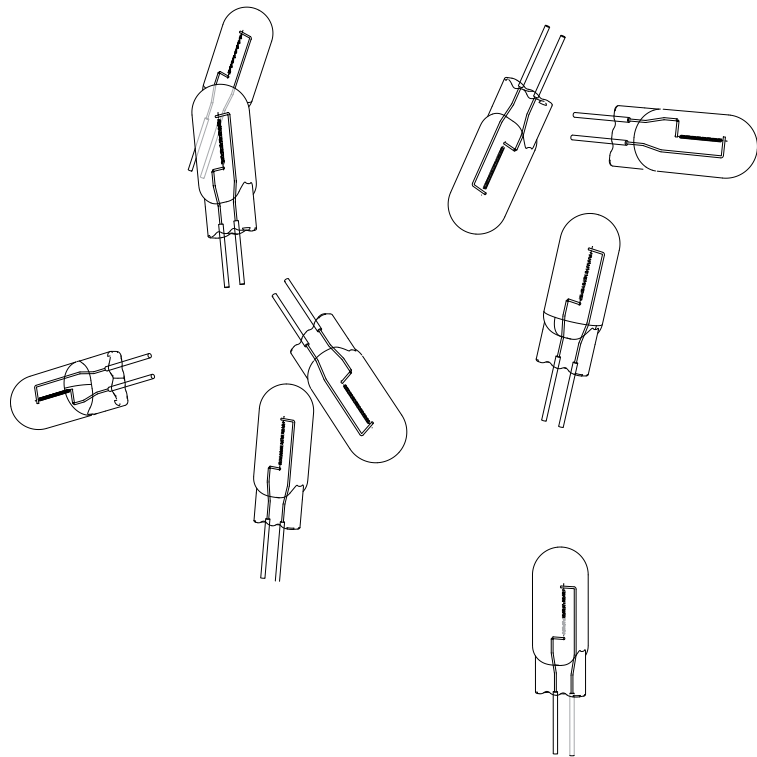

WATTAGE: 10w
 COLOUR TEMPERATURE: 2600k
 CRI: 100 (100 is daylight)
 LIGHT OUTPUT: 81 lumens
 EFFICIENCY: 8.3 lm/w
 DIMMABLE: yes
 LAMP LIFE: 20,000 hours

DESCRIPTION

The Bocci 10w xenon lamping option offers a longer-life, energy efficient alternative to typical halogen or xenon lamps. This proprietary and worldwide patent pending design utilizes Bocci's standard G4 lamp holder (9.1mm/0.36" in diameter), which is designed to accept either the Bocci xenon lamp or the Bocci LED lamp. The possibility of dual usage allows the opportunity for existing chandeliers with xenon lamping to be retrofitted on site to LED along with the appropriate driver.

This unique replacement design is unlike typical embedded xenon fixtures as it eliminates the waste associated with catastrophic failures that leave no choice but to replace the entire fixture. When it comes time to relamp, the xenon heads may simply be replaced, as with conventional lamps. Bocci xenon lamp keeps the fixture out of landfills in the future, protects your investment and introduces a significant saving of energy.

NOTES

- + Purchase replacement lamps online at www.bocci.ca/lamps
- + Requires electronic low-voltage, trailing edge dimmer
- + When replacing, do not touch bulb with bare hands

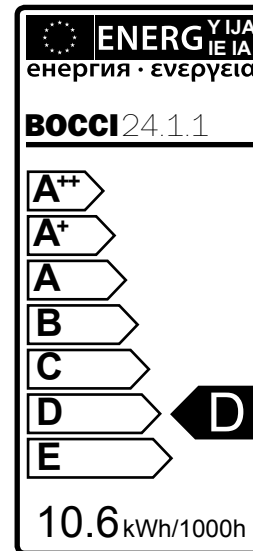

RoHS

Vancouver
sales@bocci.ca
www.bocci.ca

Berlin
europe@bocci.ca
www.bocci.ca

XENON
10W Design by Omer Arbel
 PRODUCT SPECIFICATION