

FLOS

F7401009 White

Taraxacum 1

Designed by Achille and Pier Giacomo Castiglioni, 1960



Halogen - 100W

Suspension lamp providing diffused light. White powder coated internal steel structure sprayed with a unique cocoon resin to create the diffuser which is then protected by a transparent sprayed on finish.

Are you a professional and your project needs consulting and support?

[BOOK AN APPOINTMENT](#)

Main specifications

EAN	8059607023488
Mounting	Suspension
Environments	Indoor dry location
Light Source Type	Bulb
Lamp category	Halogen
Lamp holders	E27
Ilcos	HSGS
Number of heads	1
Power (W)	100

Physical

Colour	White
Length (mm)	680
Cord length (mm)	2700
Canopy dimension (mm)	36
Canopy width (mm)	146
Net weight (kg)	2.1
Package height (mm)	520
Package width (mm)	715
Package length (mm)	715
Package volume (m3)	0.27
IP internal	20

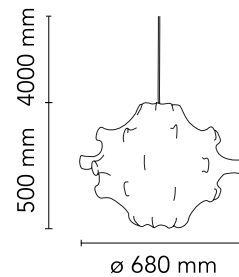

Download

[Mounting instructions](#)  PDF

[Spare Parts](#)  PDF

Photometric Files

[LDT / IES](#)  LDT

Technical Drawings

[2D](#)  ZIP

[3D](#)  ZIP



IK	IP
00	20

Schematic light drawing

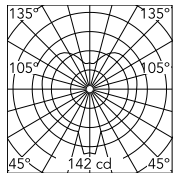

Photometric

Light distribution

Asymmetric

Electrical

Insulation class	I
Frequency (Hz)	50/60
Main voltage (Vac)	220-250
LED voltage Vf (Vdc)	null
Dimmable	Yes
Dimming interface	Remote Dimmable (Dimmer Not Included)
Batteries inside	No

Bulbs



NOT INCLUDED

RF32288

LED Lamp E27 15W 2700K T38



NOT INCLUDED

RF32289

LED Lamp E27 15W 3000K T38

Spare Parts

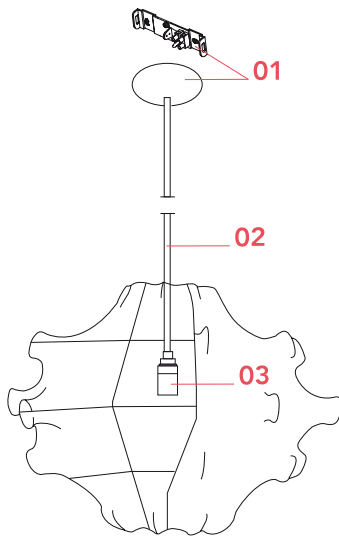

- | | | |
|-----|-------------------------|-----------|
| 01. | White rose assembly | RA3690209 |
| 02. | Wiring 2x0,75 3,2m | RF32763 |
| 03. | Electrical assembly set | RF9800200 |

DOWNLOAD



RA3690209

White rose assembly

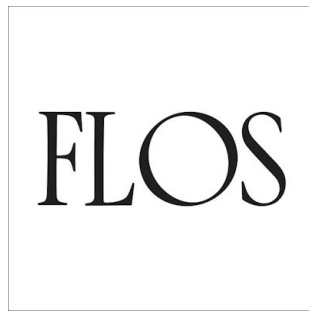

RF32763

Wiring 2x0,75 3,2m



RF9800200

Electrical assembly set