



BEAUBIEN SIMPLE SHADE





type	wall	
materials	shade :	powdercoated aluminium
	body :	powdercoated steel
	sphere :	milk glass (G50)
	hardware :	brass
	canopy :	powdercoated steel
	wire :	nylon
weight	1.5 lb / 0.7 kg	
light bulb	LED (included), 1x 3,5W	
sockets	G9	
voltage	120V / 240V	
dimmer	refer to our recommended list of dimmer models	
certifications	  	
notes	<ul style="list-style-type: none"> – must be installed by an electrician; – additional charges for modifications or for special orders – lead time between 8-9 weeks – dimensions are approximate and may vary slightly 	

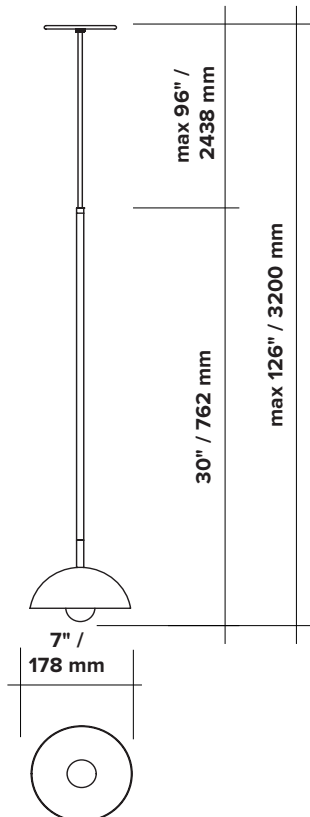

ORDER GUIDE: SKU

<u>COLLECTION</u>	<u>MODEL</u>	<u>FINISH (body + hardware)</u>	
BEA beaubien	03	BLBR black body brass hardware	
		BLGR black body graphite hardware	
BEA	03	BLBR	= BEA03BLBR <i>example</i>

<u>FINISH</u>		
		
brass	black	graphite

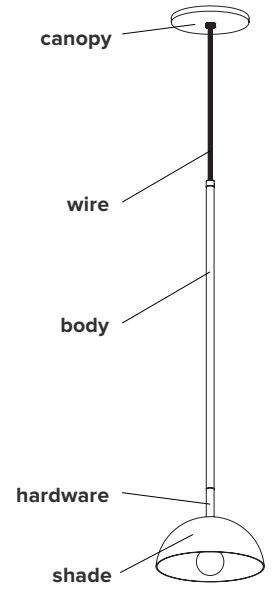

LIGHT BULB & DIMMER SPECIFICATIONS

G9 SOCKETS

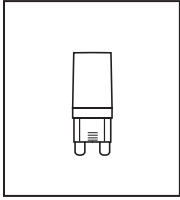

Frosted
3.5W
100V-120V / 240V
350 Lumens
2700 K
25 000 H
CRI ≥80
2 years warranty



SPHERES



G100 Ø ± 4" / 100 mm



G80 Ø ± 3" / 80 mm



G60 Ø ± 2" / 60 mm



G50 Ø ± 2" / 50 mm



tube Ø 1" / 27 mm
length ± 2" / 60 mm

DIMMER LIST COMPATIBILITY FOR G9 LED BULBS – 120V

The dimming technology offering the best results is ELV (electronic low voltage) dimmers with reverse phase or trailing edge control.

<u>DIMMER BRAND</u>	<u>MODEL NUMBER</u>	<u>MAX LEVEL</u>	<u>MIN LEVEL</u>	<u>FLICKERING</u>	<u>OVERALL QUOTE</u>
LUTRON - MAESTRO	MAELV-600	100%	0%	0%-10%	good
LUTRON - SKYLARK	SELV-300P	100%	0%	no	very good
LUTRON - SKYLARK	SELV-303P	100%	0%	no	very good
LUTRON - SKYLARK	CTELV-303P	100%	0%	no	very good
LUTRON - DIVA	DVELV-300P	100%	0%	no	very good
LEGRAND - ADORNE	TRUE UNIVERSAL	100%	30%	no	good

DIMMER LIST COMPATIBILITY FOR G9 LED BULBS – 230V

<u>DIMMER BRAND</u>	<u>MODEL NUMBER</u>	<u>MAX LEVEL</u>	<u>MIN LEVEL</u>	<u>FLICKERING</u>	<u>OVERALL QUOTE</u>
VARILIGHT	V-PRO	100%	2%	no	very good
LEGRAND - NILOÉ	3 996 35	87%	15%	no	good
NIKO	310-0280X	94%	5%	no	very good
NIKO	310-0190X	100%	1%	no	very good

*Other dimmers can yield good results and we recommend conducting your own test before final installation.

BEAUBIEN SIMPLE SHADE

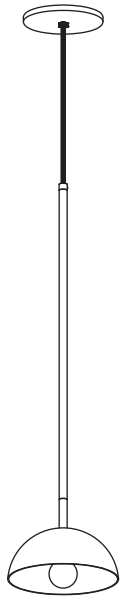

- 
- To be installed by an electrician to an electrical box
 - Use appropriate screws and anchors where necessary
 - Wear enclosed gloves when handling lamp
 - Handle materials with care. Please consult lamp maintenance sheet on our web site

1 x 

1 x 
3.5W

1 x 
G50

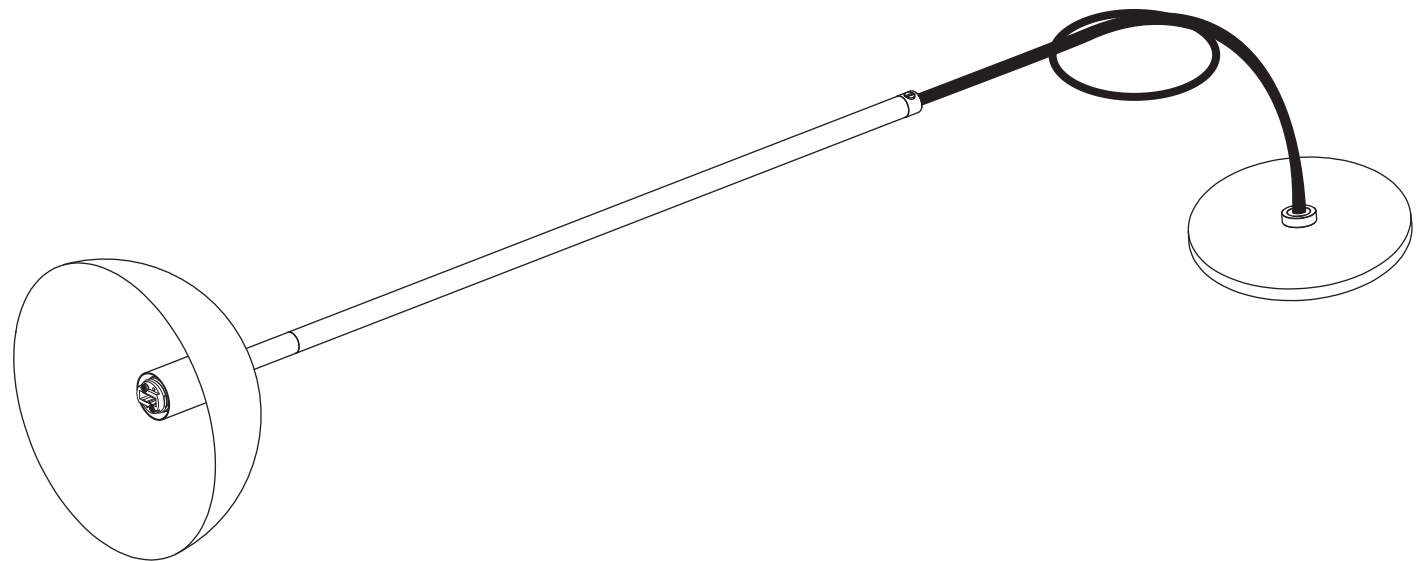

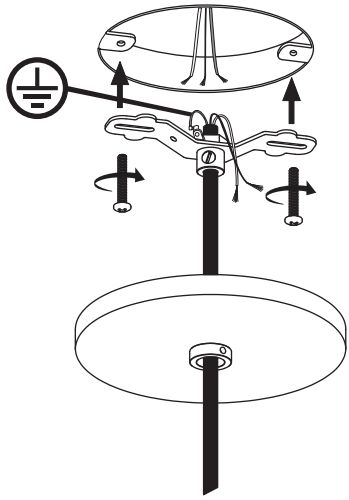

1

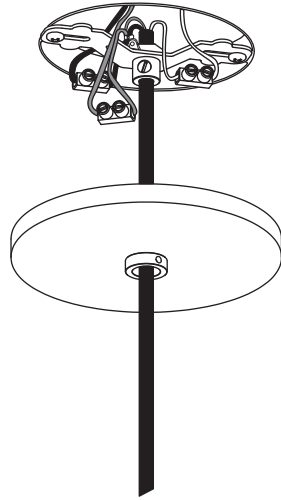

2

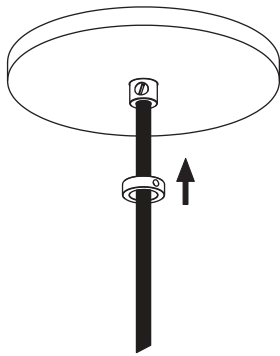

3

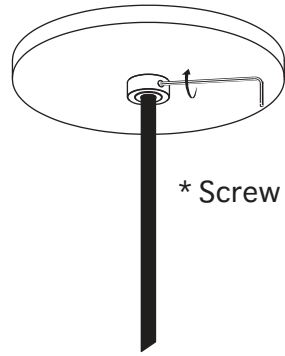

* Screw gently, but firmly

4

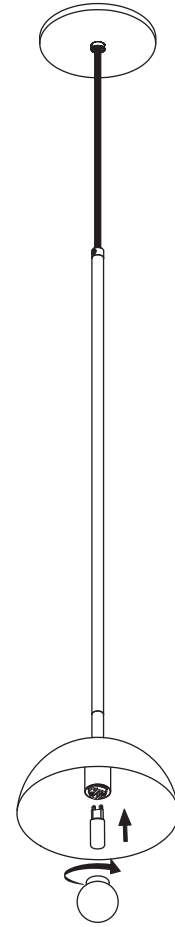

5

ENTRETIEN / MAINTENANCE

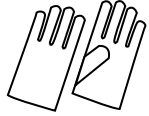

When handling your light fixture, please use enclosed cotton gloves to avoid blemishes

Unfinished Brass

If your lamp contains brass components, its look will evolve over time. We work with unfinished brass because we believe brass looks best when it is allowed to build a patina with age.

If you want to restore the lamp's original polished finish, please follow instructions for metal polish.

Instructions for use of metal polish (e.g. Collinite No.850 Metal Wax)

1. Shake product well before application.
2. Using a thin applicator pad, apply a thin amount of metal polish to small sections at a time.
3. Rub well locally to loosen the tarnish.
4. Reapply as necessary until surface is free of contaminants.
5. Before product dries, polish with a dry, clean, and soft microfiber cloth towel.

WARNING : The above instructions apply to brass components only.

Painted Surface or Graphite Finish

If your light fixture contains painted surfaces or a graphite finish, it can be cleaned using any all purpose household cleaner. Do not use solvents containing strong chemicals.

Pour manipuler la lampe, svp utiliser les gants de coton fournis dans la boîte.

Le Laiton brut

Si votre luminaire comporte des pièces en laiton, sa couleur changera. Ceci n'est pas un défaut de fabrication, mais bien le changement normal de l'apparence du laiton avec le temps. Nous avons choisi comme matière première le laiton brut car nous croyons que le laiton est à son meilleur quand il développe une patine avec l'âge.

Si vous désirez redonner une apparence neuve - polie – à votre luminaire, svp suivre les instructions pour le polissage.

Instructions pour l'utilisation de la crème de polissage (ex. Collinite No.850 Metal Wax)

1. Bien agiter le produit avant l'utilisation.
2. À l'aide d'un chamois ou chiffon doux de coton, verser une fine couche de crème, une section à la fois.
3. Frotter la surface doucement sur les traces foncées du métal terni.
4. Repasser avec la crème de polissage jusqu'à ce qu'il n'y ait plus de traces indésirables.
5. Avant que le produit ne sèche, essuyer la surface avec un chiffon en microfibres sec et propre.

ATTENTION : Les instructions ci-dessus, ne s'appliquent qu'aux pièces en laiton.

Surfaces Peintes et Fini Graphite

Si votre luminaire contient des surfaces peintes ou un fini graphite, utiliser n'importe quel produit nettoyant multi-usages standard et un chiffon doux. Éviter tous solvants contenant des produits chimiques forts.