

# 28

cluster

An innovative fabrication process that manipulates both the temperature and the direction of air flow into blown glass. The result is a slightly distorted sphere with an interior landscape of satellite shapes, including an opaque milk glass diffuser that houses either a low-voltage xenon or LED lamp.

The Cluster is suspended using coaxial cable and composed in hexagonal clusters in numerous configurations.



# 28

cluster

## Lamping

1.8w LED or 20w xenon

## Material

Blown glass, braided metal coaxial cable, electrical components, and brushed nickel or white powder coated canopy.

## Patent

US Patent # D687,740  
EU Patent # 001695834-001 to 004



LOW VOLTAGE LUMINAIRE  
E476186



±165 (6.5")

# 28

cluster

Adjustable Lengths  
Cluster canopies.

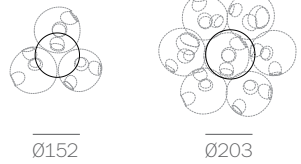
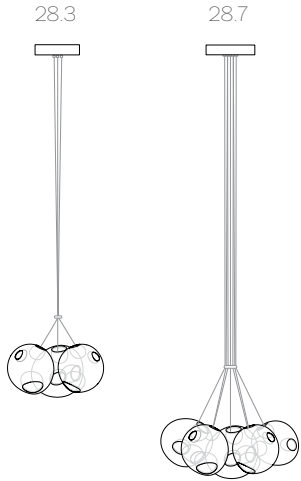

adjustable up to 3000 (10') standard  
adjustable up to 30500 (100') custom

Fixed Lengths  
Cluster canopies.

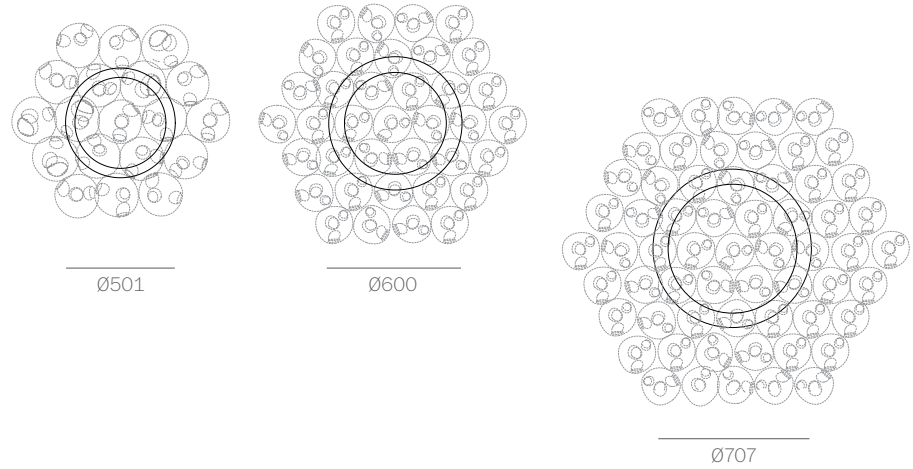
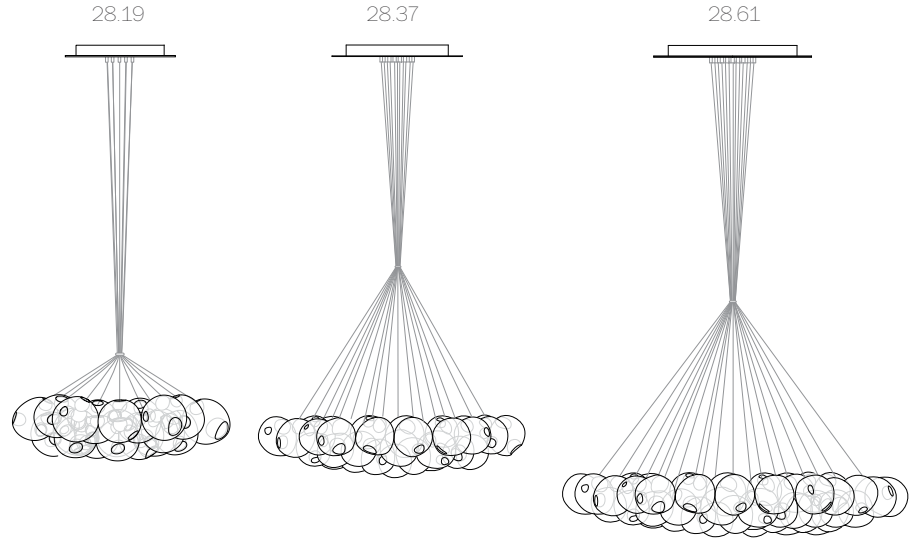

fixed length up to 3000 (10') standard  
fixed length up to 30500 (100') custom

# 28

cluster

The 28 pendant comes in 90 different colours. Please visit the [28 colour app](#) for pendant colour compositions.

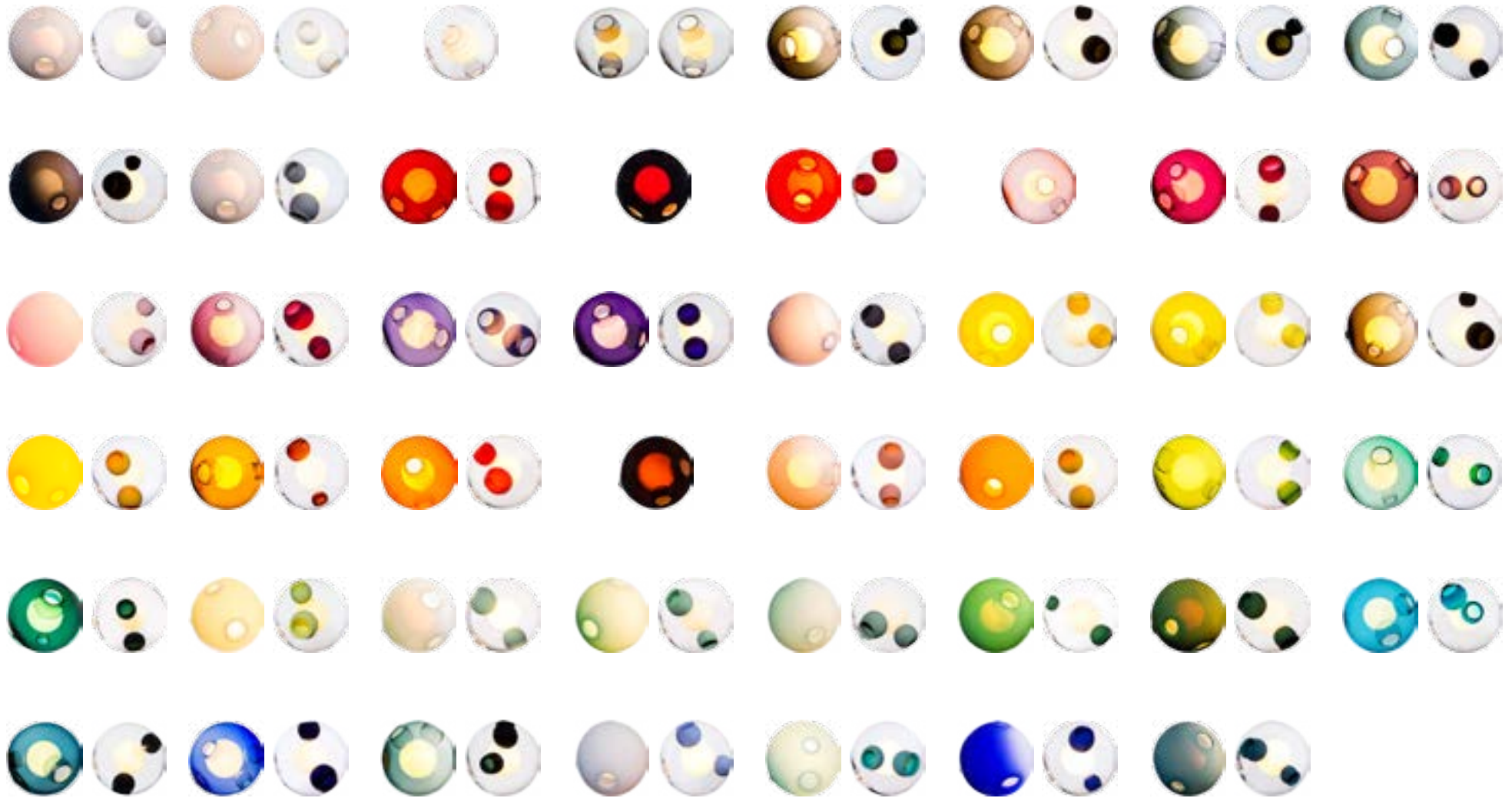

# 28

cluster



28  
cluster



Designed by Omer Arbel, 2009  
[www.bocci.ca](http://www.bocci.ca)



**BOCCI**

© 2018, Bocci Design and Manufacturing Inc.  
Any inquiries should be directed to: [info@bocci.ca](mailto:info@bocci.ca)

28  
cluster



28  
cluster





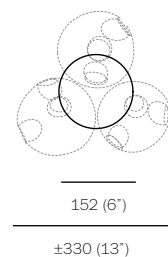
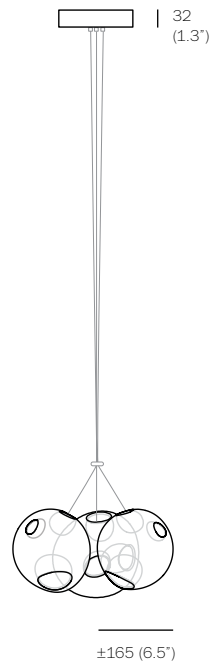
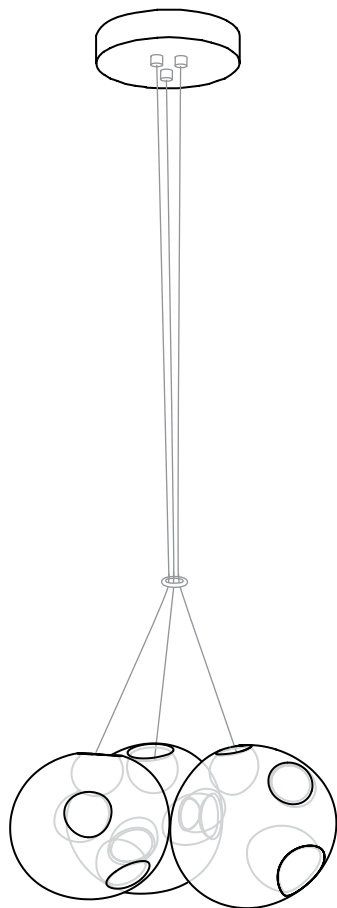

32  
(1.3')  
adjustable  
up to 3000  
(10')  
standard

adjustable  
up to 30500  
(100')  
custom

min.  
drop length  
500(19.7')

approx 3.5kg (7.7lb)

PENDANTS: three  
MOUNTING: brushed nickel canopy 152mm (6") in diameter x 32mm (1.3") deep  
LAMPING: 1.8w LED or 20w xenon  
COAX: adjustable. 3000mm (10') standard / up to 30500mm (100') maximum  
MATERIALS: blown glass, braided metal coaxial cable, electrical components, brushed nickel canopy  
WEIGHT: approximately 3.5kg (7.7lb)  
TRANSFORMERS: integral

#### DESCRIPTION

28.3 is a cluster of three 28 pendants hung from a round canopy. The pendants hang in shape of a hexagonal bouquet, bundled together by an adjustable ring, which changes the curvature of the piece and its proportional reading.

28 is an exploration of specificity in manufacturing. Instead of designing form itself, here the intent was to design a system of making that yields form. Individual 28 pendants result from a complex glass blowing technique whereby air pressure is intermittently introduced into and then removed from a glass matrix which is intermittently heated and then rapidly cooled. The result is a distorted spherical shape with a composed collection of imploded inner shapes, one of which acts as a shade for the light source.

Standard 28s are made with clear glass exterior spheres and milk white interior lamp holder cavities. 28s are possible with infinite versatility in colour compositions, sizes and shapes.

#### NOTES

- + Purchase replacement lamps online at [www.bocci.ca/lamps](http://www.bocci.ca/lamps)
- + Unless otherwise noted when ordering, all fixtures will be outfitted to be xenon compatible
- + As an alternative to a built-in transformer, Bocci recommends mounting transformers remotely in an easily accessible and hidden location for ease of long-term maintenance.

US Patent # D687,740  
EU Patent # 001695834-001 to 004

Made in Vancouver, Canada

Vancouver  
[sales@boscci.ca](mailto:sales@boscci.ca)  
[www.boscci.ca](http://www.boscci.ca)

Berlin  
[europa@boscci.ca](mailto:europa@boscci.ca)  
[www.boscci.ca](http://www.boscci.ca)



CLUSTER

# 28.3

Design by Omer Arbel  
PRODUCT SPECIFICATION

# BOCCI

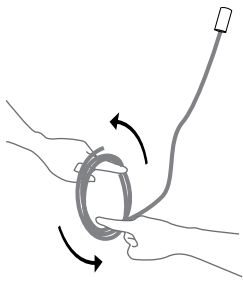

1

Very carefully uncoil the braided coaxial cable in a spool like manner. Insert your index fingers into opposite sides of the roll then rotate your fingers around each other to unroll the coaxial cable.

Use patience: allow the cable to uncoil completely to avoid kinks.

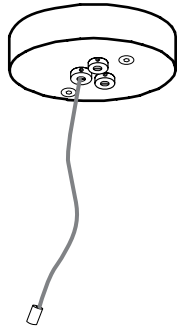

2

Determine the overall drop for the pendant fixture.

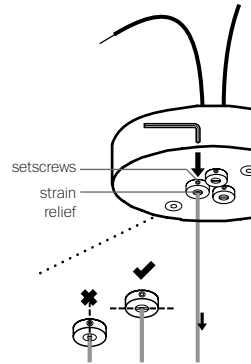

3

Thread the coaxial cables through the canopy, use a 2mm Allen key to loosen the setscrew in the canopy and gently feed the cable through until you have reached your desired drop length.

Use Allen key to tighten the setscrew to hold the strain relief and secure the coaxial cable at its new length. Perform a gentle tug test to ensure it is secure.

**DO NOT OVERTIGHTEN.**

Note: The strain relief is a black plastic collar around the coaxial cable. There is a single slot opening on the side of the strain relief component. It is essential that this opening is oriented at 90 degrees to set screw chamber. There can be no contact between the set screw and the cable.

**RISK OF ELECTRIC SHORT!**

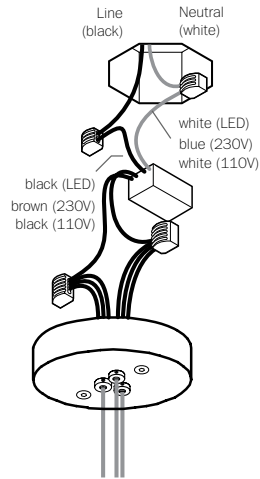

4

Xenon (110V) or LED: connect the black wire to black and white wire to white wire.

Xenon (230V): connect black wire to brown wire and white wire to blue wire.

Connect the coaxial cable to the open slots in the terminal block on the 12V side of the transformers.

Ensure that the braided outer wires are all connected to one 12V output wire and all inner insulated wires are connected to the other or a short will occur.

Once all coaxial connections are made, lift the fixture into position and connect the line voltage to the open slot in the appropriate terminal block.

5

The client is responsible to ensure fasteners are attached to a robust structural substrate.

Tuck the transformer and wiring into the canopy. Line up the fastener holes or connect directly to structural ceiling surface using the fasteners provided.

Note: The glass pendants function as a heat sink for the xenon lamps. Please do not leave the fixture on without the pendants installed as it can cause the lamps to overheat and stop working.

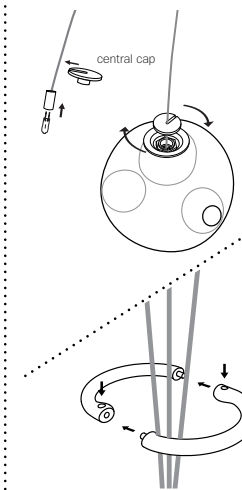
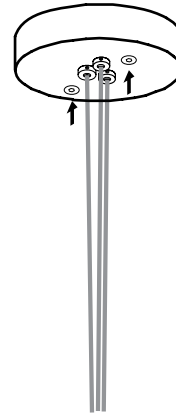

6

Bocci lamps are included. Plug the lamp into the socket. Do not touch the lamp with your bare hands.

Remove the center cap from 28 pendant. Install 28 pendant by sliding the center cap onto the coaxial cable, gently insert the lamp into the pendant, then tighten the center cap connection by hand.

**DO NOT OVERTIGHTEN.**

Remove the protective film from the center cap after assembly.

Note: when using a dimmer use only low voltage electronic dimmer.

Prior to installing the ring around the coaxial cables, ensure that the pendants are composed in their intended hexagonal formation.

Gather the coaxial cables then install the ring with setscrews face up.



7

Clean fingerprints from glass surfaces.

Turn fixture on.

For additional assistance, please contact Bocci:

Vancouver  
sales@bocci.ca  
www.bocci.ca

Berlin  
europe@bocci.ca  
www.bocci.ca

US Patent # D687,740  
EU Patent # 001695834-001 to 004

Made in Vancouver, Canada



CLUSTER

28.3

Design by Omer Arbel  
PRODUCT INSTALLATION INSTRUCTIONS

## 120/240V LED Driver - 4W

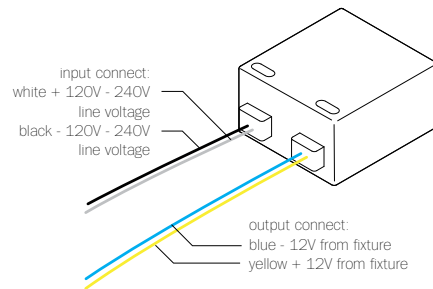

### B-L03U-12V

PRIMARY: AC 100 - 240V, 120mA, 50/60Hz

SECONDARY: Max. 12V DC (4.2w max.)

LAMPING: 1w LED lamps: 1-3  
1.5w LED lamps: 1-2  
1.8w LED lamps: 1-2  
2.3w ring LED lamps: 1

DIMMING: Non-dimmable

NOTES: Constant voltage  
Class 2 power unit  
For LED lamps only

DIMENSION: 43mm (1.7") x 41mm (1.6") x 22mm (0.8")

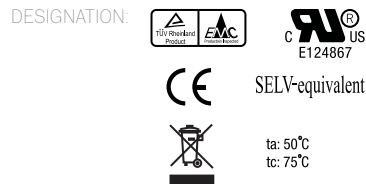

## 120/240V LED Driver - 8W

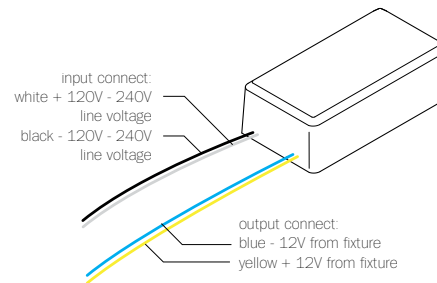

### B-L07U-12V

PRIMARY: AC 100 - 240V, 170mA, 50/60Hz

SECONDARY: Max. 12V DC (8.4w max.)

LAMPING: 1w LED lamps: 1-7  
1.5w LED lamps: 1-5  
1.8w LED lamps: 1-4  
2.3w ring LED lamps: 1-3

DIMMING: Non-dimmable

NOTES: Constant voltage  
Class 2 power unit  
For LED lamps only

DIMENSION: 65mm (2.5") x 35mm (1.3") x 28mm (1.1")

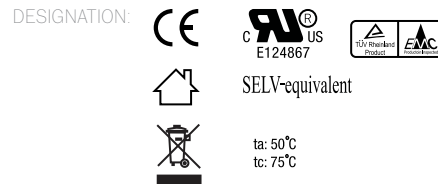

## 120/240V LED Driver - 24W

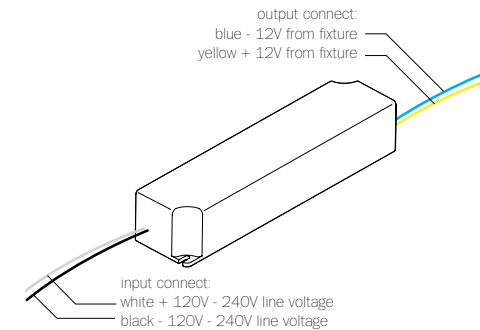

### B-L24U-12V

PRIMARY: AC 100 - 240V, 300mA, 60Hz

SECONDARY: Max. 12V DC (24w max.)

LAMPING: 1w LED lamps: 1-24  
1.5w LED lamps: 1-16  
1.8w LED lamps: 1-13  
2.3w ring LED lamps: 1-10

DIMMING: Dimmable using minimum 8 lamps and improves with larger load. Use low voltage electronic dimmers only

NOTES: Short Circuit Protection  
Constant voltage  
Class 2 power unit  
For LED lamps only

DIMENSION: 42mm (1.7") x 170mm (6.7") x 33mm (1.3")



## 120V Transformer

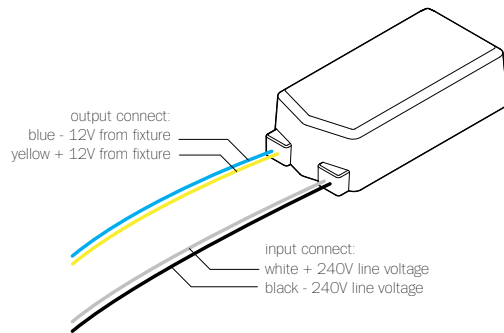

### WH-601E6A-3C

PRIMARY: AC 120V 50/60Hz, 500mA

SECONDARY: 12V AC (10w min. - 60w max.)

LAMPING: 10w lamps: 1-6  
20w lamps: 1-3

DIMMING: Dimmable using minimum 2 x 10w lamps or 1 x 20w lamp using low voltage electronic and trailing edge dimmers only.

NOTES: Auto stop protected  
Class 2 power unit  
Electronic transformer for xenon lamps only

DIMENSION: 70mm (2.8") x 36mm (1.4") x 20mm (0.75")

DESIGNATION:   E124867

## 240V Transformer

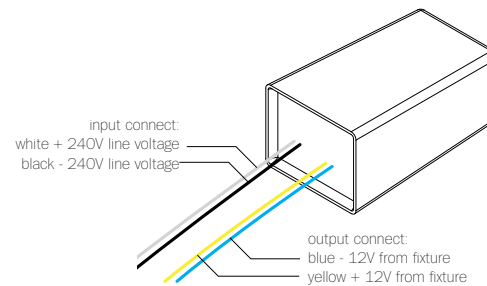

### WH-602W

PRIMARY: AC 230V-240V 50Hz, 260mA

SECONDARY: 11.5V AC (10w min. - 60w max.)

LAMPING: 10w lamps: 1-6  
20w lamps: 1-3

DIMMING: Dimmable using minimum 2 x 10w lamps or 1 x 20w lamp using low voltage electronic and trailing edge dimmers only.

NOTES: Auto stop protected  
Class 2 power unit  
Electronic transformer for xenon lamps only

DIMENSION: 63mm (2.5") x 35mm (1.4") x 26mm (1")

DESIGNATION:    

IP65   ta: 50°C  
tc: 80°C

## 240V Transformer

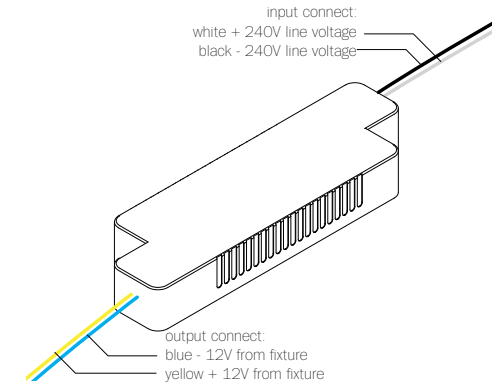

### WH-602S

PRIMARY: AC 230V-240V 50Hz, 260mA









SECONDARY: 11.5V AC (10w min. - 60w max.)

LAMPING: 10w lamps: 1-6  
20w lamps: 1-3

DIMMING: Dimmable using minimum 2 x 10w lamps or 1 x 20w lamp using low voltage electronic and trailing edge dimmers only.

NOTES: Auto stop protected  
Class 2 power unit  
Electronic transformer for xenon lamps only

DIMENSION: 117mm (4.5") x 36mm (1.4") x 16mm (0.6")

DESIGNATION:     
     
 

XENON

# Transformers

PRODUCT SPECIFICATION

For additional assistance, please contact Bocci:

Vancouver  
sales@bocci.ca  
www.bocci.ca

Berlin  
europe@bocci.ca  
www.bocci.ca

© 2018, Bocci Design and Manufacturing Inc. All rights reserved. Any inquiries should be directed to: info@bocci.ca

# BOCCI

LED

1.8W

Design by Omer Arbel  
PRODUCT SPECIFICATION

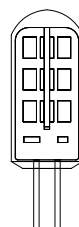
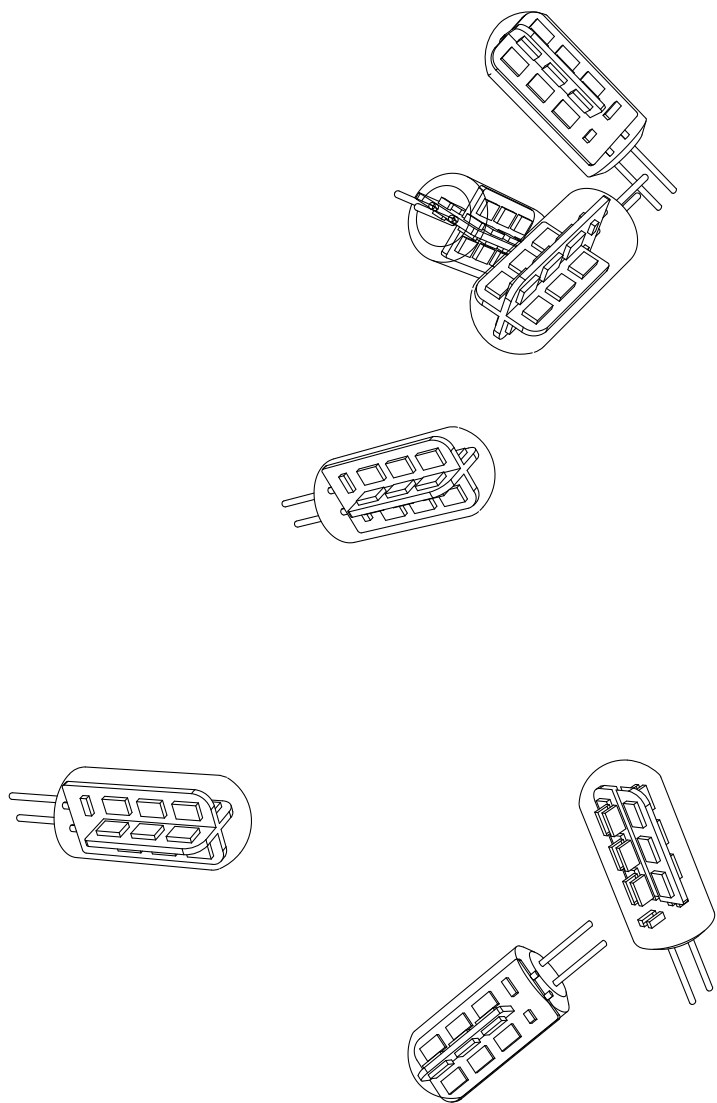

38 (1.5")



12.5 (0.5")

WATTAGE: 1.8w  
 COLOUR TEMPERATURE: 2600k  
 CRI: 75 (100 is daylight)  
 LIGHT OUTPUT: 142 lumens  
 EFFICIENCY: 60 lm/w  
 LAMP LIFE: 25,000 hours

#### DESCRIPTION

The Bocci 1.8w LED lamping option offers a longer-life, energy efficient alternative to typical halogen or xenon lamps. This proprietary and worldwide patent pending design utilizes Bocci's standard G4 lamp holder (9.1mm/0.36" in diameter), which is designed to accept either the Bocci xenon lamp or the Bocci LED lamp. The possibility of dual usage allows the opportunity for existing chandeliers with xenon lamping to be retrofitted on site to LED along with the appropriate driver.

This unique replacement design is unlike typical embedded xenon fixtures as it eliminates the waste associated with catastrophic failures that leave no choice but to replace the entire fixture. When it comes time to relamp, the xenon heads may simply be replaced, as with conventional lamps. Bocci xenon lamp keeps the fixture out of landfills in the future, protects your investment and introduces a significant saving of energy.

#### NOTES

+ Purchase replacement lamps online at [www.bocci.ca/lamps](http://www.bocci.ca/lamps)

RoHS 

Vancouver  
[sales@bocci.ca](mailto:sales@bocci.ca)  
[www.bocci.ca](http://www.bocci.ca)

Berlin  
[europe@bocci.ca](mailto:europe@bocci.ca)  
[www.bocci.ca](http://www.bocci.ca)

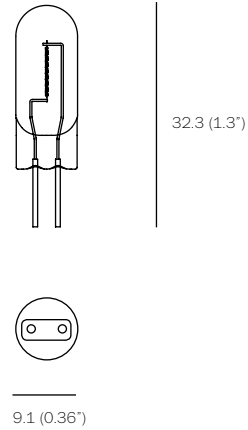
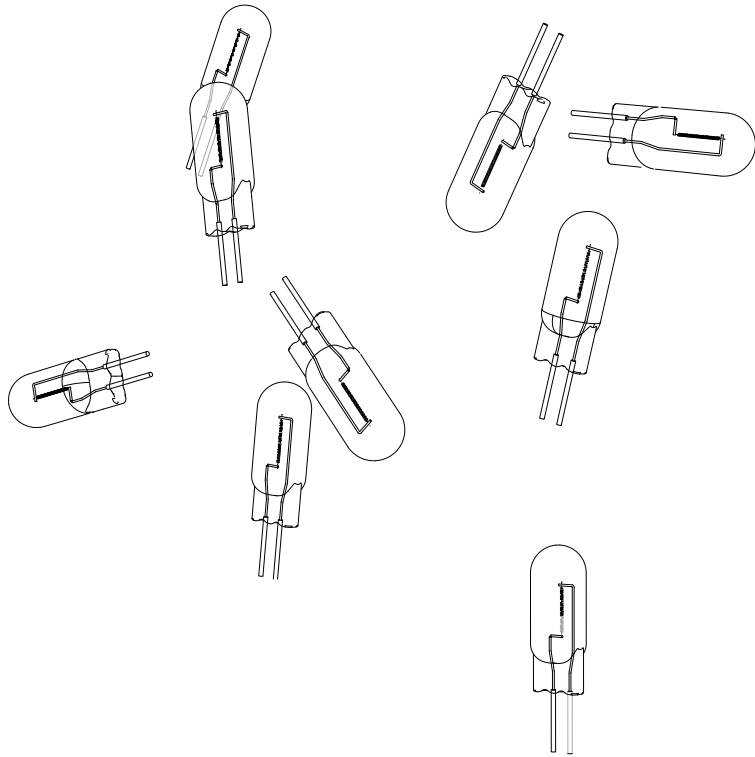

WATTAGE: 20w  
 COLOUR TEMPERATURE: 2600k  
 CRI: 100 (100 is daylight)  
 LIGHT OUTPUT: 196 lumens  
 EFFICIENCY: 19.03 lm/w  
 DIMMABLE: yes  
 LAMP LIFE: 20,000 hours

**DESCRIPTION**

The Bocci 20w xenon lamping option offers a longer-life, energy efficient alternative to typical halogen or xenon lamps. This proprietary and worldwide patent pending design utilizes Bocci's standard G4 lamp holder (9.1mm/0.36" in diameter), which is designed to accept either the Bocci xenon lamp or the Bocci LED lamp. The possibility of dual usage allows the opportunity for existing chandeliers with xenon lamping to be retrofitted on site to LED along with the appropriate driver.

This unique replacement design is unlike typical embedded xenon fixtures as it eliminates the waste associated with catastrophic failures that leave no choice but to replace the entire fixture. When it comes time to relamp, the xenon heads may simply be replaced, as with conventional lamps. Bocci xenon lamp keeps the fixture out of landfills in the future, protects your investment and introduces a significant saving of energy.

**NOTES**

- + Purchase replacement lamps online at [www.bocci.ca/lamps](http://www.bocci.ca/lamps)
- + Requires electronic low-voltage, trailing edge dimmer
- + When replacing, do not touch bulb with bare hands

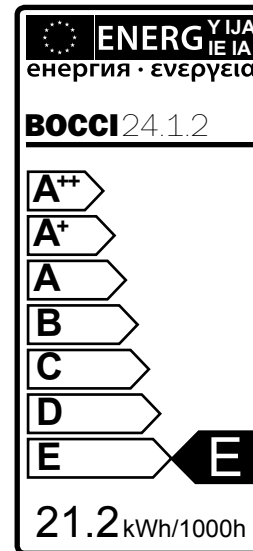

RoHS

Vancouver  
[sales@bocci.ca](mailto:sales@bocci.ca)  
[www.bocci.ca](http://www.bocci.ca)

Berlin  
[europe@bocci.ca](mailto:europe@bocci.ca)  
[www.bocci.ca](http://www.bocci.ca)

XENON  
**20W** Design by Omer Arbel  
 PRODUCT SPECIFICATION