

# 73

standard

73 results from blowing liquid glass into a folded and highly heat-resistant ceramic fabric vessel. The resulting shape has a formal and textural expression intuitively associated with fabric, which becomes permanent and rigid as it cools. A flat LED is positioned to fill the resulting volume with diffuse light, accentuating the volumetric perception of the piece.



73  
standard

Lamping

2.3w LED

Material

blown glass, braided metal coaxial cable, electrical components, brushed nickel or white powder coated canopy

Patent

US Patent # D762,323 S  
EU Patent # 002633230-0001 - 0003



LOW VOLTAGE LUMINAIRE  
E476186



standard size pendant  
±260-305 (10.5"-12")

oversized pendant  
±400 (15.75")

# 73

standard

Surface Mount  
Wall/ceiling

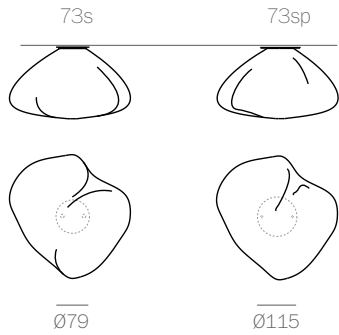

Adjustable  
Lengths  
Random canopies.

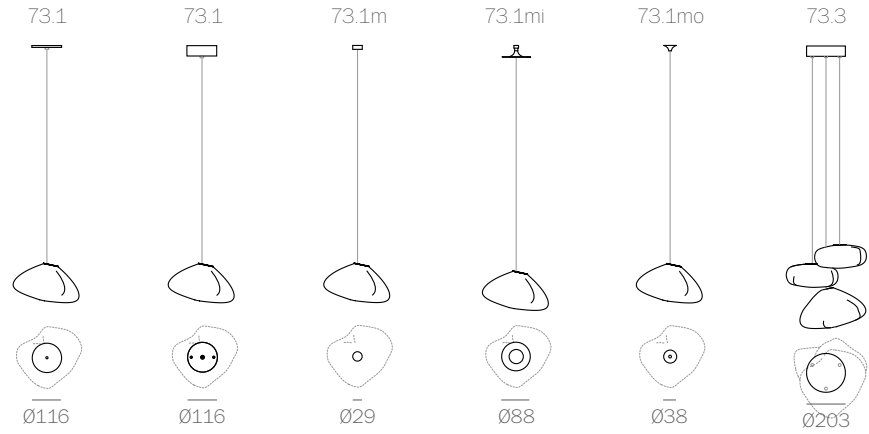

adjustable  
up to  
3000 (10')  
standard

adjustable  
up to  
30500  
(100')  
custom

Fixed Lengths  
Random canopies.

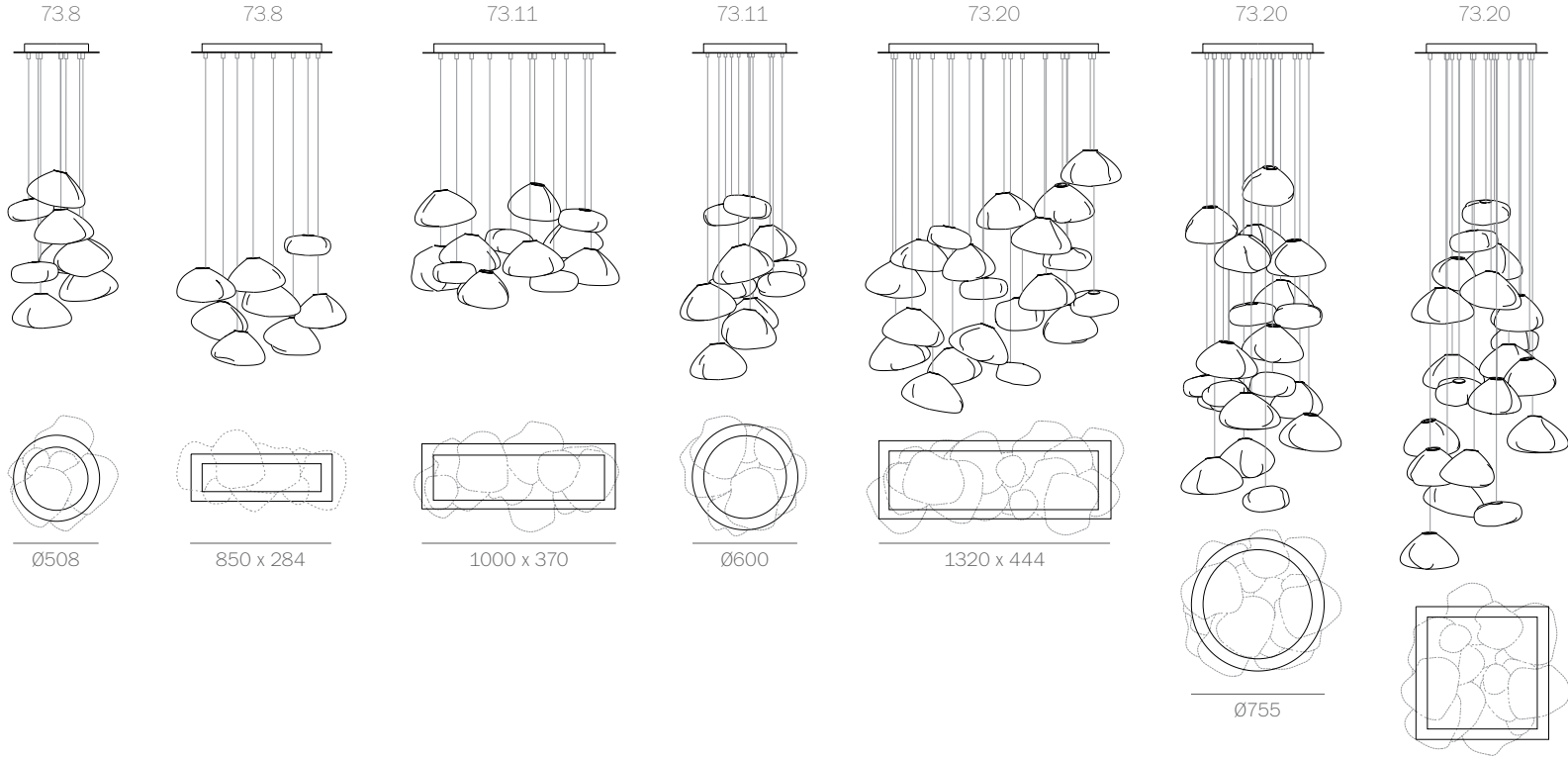

fixed  
length  
up to  
3000 (10')  
standard

fixed  
length  
up to  
30500  
(100')  
custom

755

**BOCCI**

73  
standard



73  
standard



73  
standard



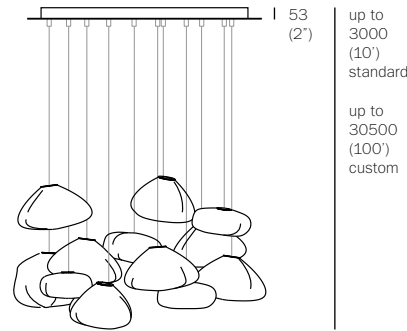
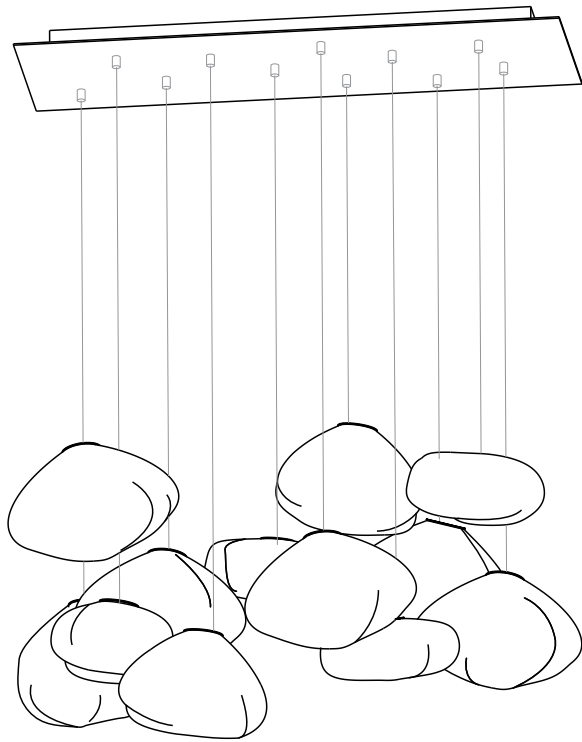

standard size pendant  
±260 - 305 (10.5" - 12")  
oversized pendant  
±400 (15.75")

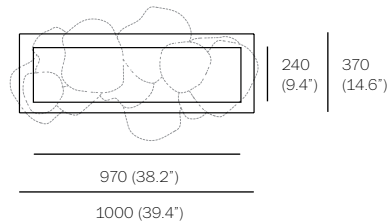

PENDANTS: eleven  
MOUNTING: white powder coated rectangular canopy 1000mm (39.4') x 370mm (14.6') x 53mm (2') deep  
LAMPING: 2.3w LED  
COAX: fixed lengths. 3000mm (10') standard / up to 30500mm (100') maximum  
MATERIALS: blown glass, braided metal coaxial cable, electrical components, white powder coated canopy  
WEIGHT: approx. 40kg (89lb)  
TRANSFORMERS: integral

#### DESCRIPTION

73.11 is a random configuration of eleven 73 pendants hung from a rectangular canopy. The drop lengths of the pendants are randomized between a client specified range of heights to variously cluster and scatter. The result is an ambient installation or field of light.

The 73 is formed by blowing liquid glass into a folded and highly heat-resistant ceramic fabric vessel. The resulting shape has a formal and textural expression intuitively associated with fabric, which becomes permanent and rigid as it cools. Each 73 is completely unique in proportion, size and shape.

#### NOTES

- + Purchase replacement lamps online at [www.bocci.ca/lamps](http://www.bocci.ca/lamps)
- + As an alternative to the junction box transformer, Bocci recommends mounting transformers remotely in an easily accessible and hidden location for ease of long-term maintenance.

US Patent # D762,323 S  
EU Patent # 002633230-0001 - 0003

Made in Vancouver, Canada

Vancouver  
[sales@bocci.ca](mailto:sales@bocci.ca)  
[www.bocci.ca](http://www.bocci.ca)

Berlin  
[europe@bocci.ca](mailto:europe@bocci.ca)  
[www.bocci.ca](http://www.bocci.ca)

approx. 40kg (89lb)

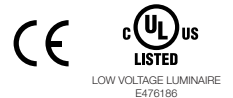

RECTANGLE

# 73.11

Design by Omer Arbel  
PRODUCT SPECIFICATION

© 2018, Bocci Design and Manufacturing Inc. All rights reserved. Any inquiries should be directed to: [info@bocci.ca](mailto:info@bocci.ca)

# BOCCI

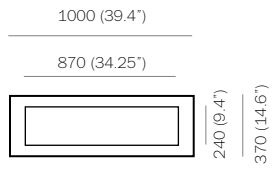

1

Measure and mark the light fixture canopy position on the ceiling

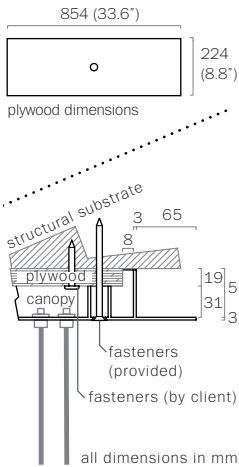

2

Note: The client is responsible for providing a robust 19mm (3/4") plywood backing or wood blocking to securely anchor to the structural substrate.

Connections from the plywood to the structural substrate are the client's responsibility.

Measure the plywood so that it fits within the canopy side walls (refer to detail above).

Anchor the plywood backing to the structural ceiling substrate.

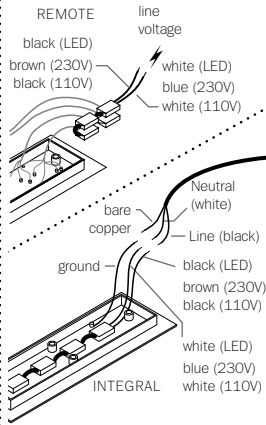

3

Connect transformers inside the canopy to line voltage.

Xenon (110V) or LED: connect the black wire to black and white wire to white wire.

Xenon (230V): connect black wire to brown wire and white wire to blue wire.

For the ground connection, connect the green wire with yellow stripe to the bare copper wire or green wire in the junction box.

Note: As an option, Bocci recommends mounting transformers remotely in a close, accessible and hidden location for ease of long term maintenance. Installation to be done by certified personnel to ensure compliance with the code.

4

Anchor canopy into the plywood backing using the fasteners provided.

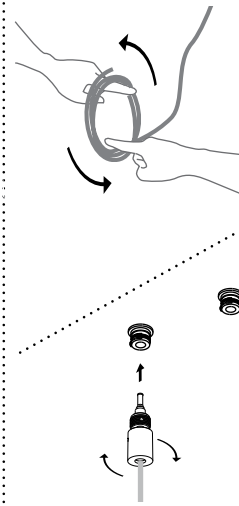

5

Very carefully uncoil the braided coaxial cable in a spool like manner. Insert your index fingers into opposite sides of the roll then rotate your fingers around each other to unroll the coaxial cable.

Use patience: allow the cable to uncoil completely to avoid kinks.

Each pendant terminates in a "headphone jack" type connector, which plugs into a receiving receptacle in the canopy. Clients are encouraged to compose their own pendant configuration on site, thus creating a truly unique fixture. After plugging in each pendant, turn the threaded sheath into place by hand ensuring that it is adequately tightened. Tools are not required.

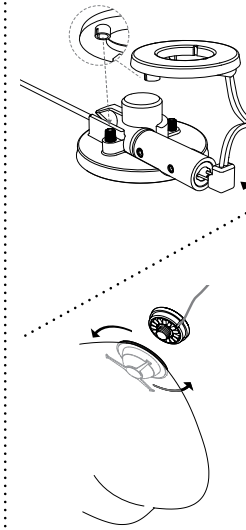

6

Slide the lamp socket into the 73 cap.

Plug Bocci 2.3w LED lamp into the lamp socket.

Push the lamp holder onto the two posts located on the cap. Make sure the short step on the lamp holder matches with the pin on the high step of the cap.

To attach the glass pendant to the cap simply rotate it on.

Note: Rotate the glass - not the cap, otherwise the coax will twist.

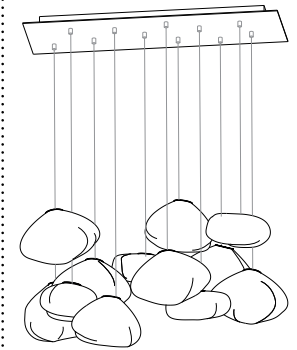

7

Clean fingerprints from glass surfaces.

Turn fixture on.

For additional assistance, please contact Bocci:

Vancouver  
sales@bocci.ca  
www.bocci.ca

Berlin  
europe@bocci.ca  
www.bocci.ca

US Patent # D762,323 S  
EU Patent # 002633230-0001 - 0003

Made in Vancouver, Canada

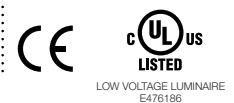

RECTANGLE

73.11

Design by Omer Arbel  
PRODUCT INSTALLATION INSTRUCTIONS

© 2018, Bocci Design and Manufacturing Inc. All rights reserved. Any inquiries should be directed to: info@bocci.ca

**BOCCI**



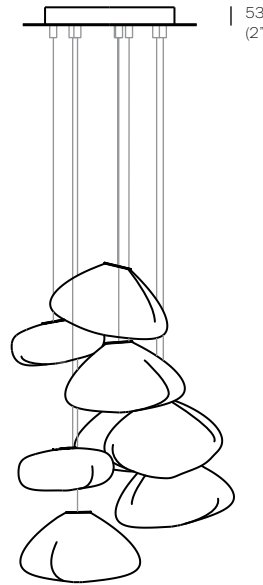
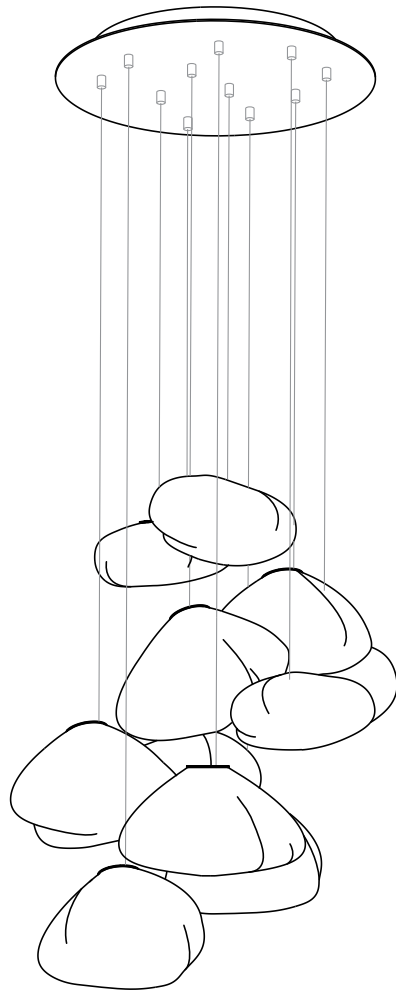

53  
(2')

up to 3000  
(10')  
standard

up to 30500  
(100')  
custom

standard size pendant  
±260 - 305 (10.5' - 12')

oversized pendant  
±400 (15.75')

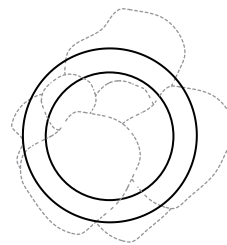

470 (18.5')

600 (23.6')

PENDANTS: eleven

MOUNTING: white powder coated round canopy 600mm (23.6") in diameter x 53mm (2") deep

LAMPING: 2.3w LED

COAX: fixed lengths. 3000mm (10') standard / up to 30500mm (100') maximum

MATERIALS: blown glass, braided metal coaxial cable, electrical components, white powder coated canopy

WEIGHT: approx. 43kg (94lb)

TRANSFORMERS: integral

#### DESCRIPTION

73.11 is a random configuration of eleven 73 pendants hung from a round canopy. The drop lengths of the pendants are randomized between a client specified range of heights to variously cluster and scatter. The result is an ambient installation or field of light.

The 73 is formed by blowing liquid glass into a folded and highly heat-resistant ceramic fabric vessel. The resulting shape has a formal and textural expression intuitively associated with fabric, which becomes permanent and rigid as it cools. Each 73 is completely unique in proportion, size and shape.

#### NOTES

- + Purchase replacement lamps online at [www.bocci.ca/lamps](http://www.bocci.ca/lamps)
- + As an alternative to the junction box transformer, Bocci recommends mounting transformers remotely in an easily accessible and hidden location for ease of long-term maintenance.

US Patent # D762,323 S  
EU Patent # 002633230-0001 - 0003

Made in Vancouver, Canada

Vancouver  
[sales@bocci.ca](mailto:sales@bocci.ca)  
[www.bocci.ca](http://www.bocci.ca)

Berlin  
[europe@bocci.ca](mailto:europe@bocci.ca)  
[www.bocci.ca](http://www.bocci.ca)

approx. 43kg (94lb)

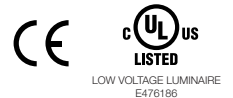

ROUND

# 73.11

Design by Omer Arbel  
PRODUCT SPECIFICATION

# BOCCI

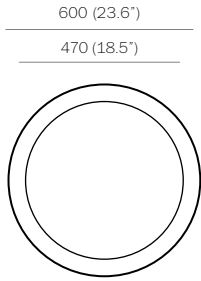

1

Measure and mark the light fixture canopy position on the ceiling

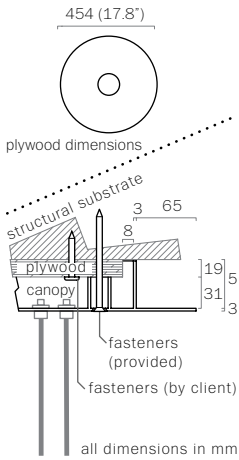

2

Note: The client is responsible for providing a robust 19mm (3/4") plywood backing or wood blocking to securely anchor to the structural substrate.

Connections from the plywood to the structural substrate are the client's responsibility.

Measure the plywood so that it fits within the canopy side walls (refer to detail above).

Anchor the plywood backing to the structural ceiling substrate.

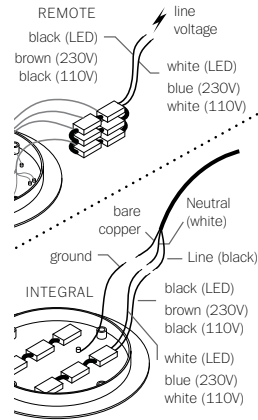

3

Connect transformers inside the canopy to line voltage.

Xenon (110V) or LED: connect the black wire to black and white wire to white wire.

Xenon (230V): connect black wire to brown wire and white wire to blue wire.

For the ground connection, connect the green wire with yellow stripe to the bare copper wire or green wire in the junction box.

Note: As an option, Bocci recommends mounting transformers remotely in a close, accessible and hidden location for ease of long term maintenance. Installation to be done by certified personnel to ensure compliance with the code.

4

Anchor canopy into the plywood backing using the fasteners provided.

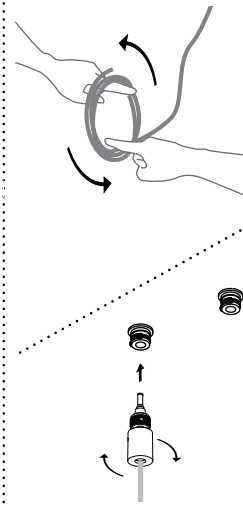
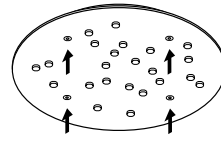

5

Very carefully uncoil the braided coaxial cable in a spool like manner. Insert your index fingers into opposite sides of the roll then rotate your fingers around each other to unroll the coaxial cable.

Use patience: allow the cable to uncoil completely to avoid kinks.

Each pendant terminates in a "headphone jack" type connector, which plugs into a receiving receptacle in the canopy. Clients are encouraged to compose their own pendant configuration on site, thus creating a truly unique fixture. After plugging in each pendant, turn the threaded sheath into place by hand ensuring that it is adequately tightened. Tools are not required.

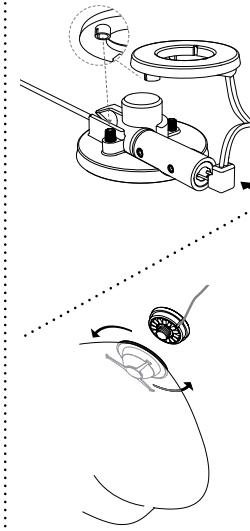

6

Slide the lamp socket into the 73 cap.

Plug Bocci 2.3w LED lamp into the lamp socket.

Push the lamp holder onto the two posts located on the cap. Make sure the short step on the lamp holder matches with the pin on the high step of the cap.

To attach the glass pendant to the cap simply rotate it on.

Note: Rotate the glass - not the cap, otherwise the coax will twist.

7

Clean fingerprints from glass surfaces.

Turn fixture on.

For additional assistance, please contact Bocci:

Vancouver  
sales@bocci.ca  
www.bocci.ca

Berlin  
europe@bocci.ca  
www.bocci.ca

US Patent # D762,323 S  
EU Patent # 002633230-0001 - 0003

Made in Vancouver, Canada

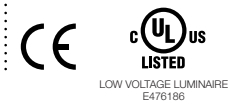

ROUND

73.11

Design by Omer Arbel  
PRODUCT INSTALLATION INSTRUCTIONS

© 2018, Bocci Design and Manufacturing Inc. All rights reserved. Any inquiries should be directed to: info@bocci.ca

**BOCCI**

## 120/240V LED Driver - 4W

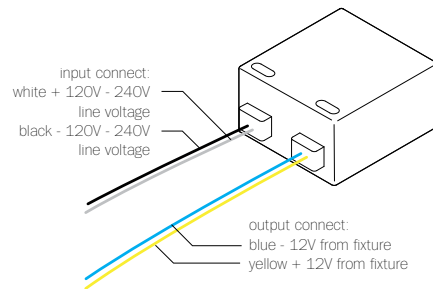

### B-L03U-12V

PRIMARY: AC 100 - 240V, 120mA, 50/60Hz

SECONDARY: Max. 12V DC (4.2w max.)

LAMPING: 1w LED lamps: 1-3  
1.5w LED lamps: 1-2  
1.8w LED lamps: 1-2  
2.3w ring LED lamps: 1

DIMMING: Non-dimmable

NOTES: Constant voltage  
Class 2 power unit  
For LED lamps only

DIMENSION: 43mm (1.7") x 41mm (1.6") x 22mm (0.8")

DESIGNATION:



## 120/240V LED Driver - 8W

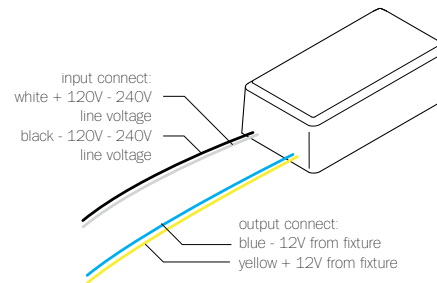

### B-L07U-12V

PRIMARY: AC 100 - 240V, 170mA, 50/60Hz

SECONDARY: Max. 12V DC (8.4w max.)

LAMPING: 1w LED lamps: 1-7  
1.5w LED lamps: 1-5  
1.8w LED lamps: 1-4  
2.3w ring LED lamps: 1-3

DIMMING: Non-dimmable

NOTES: Constant voltage  
Class 2 power unit  
For LED lamps only

DIMENSION: 65mm (2.5") x 35mm (1.3") x 28mm (1.1")

DESIGNATION:

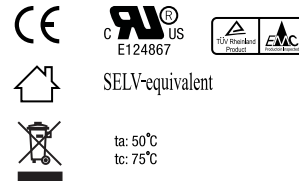

## 120/240V LED Driver - 24W

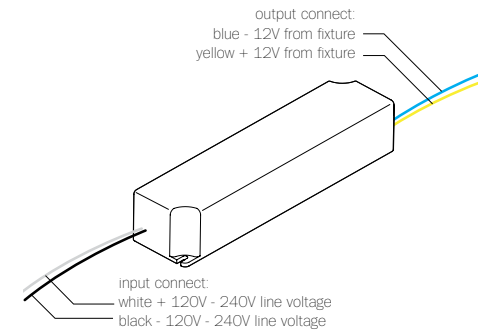

### B-L24U-12V

PRIMARY: AC 100 - 240V, 300mA, 60Hz

SECONDARY: Max. 12V DC (24w max.)

LAMPING: 1w LED lamps: 1-24  
1.5w LED lamps: 1-16  
1.8w LED lamps: 1-13  
2.3w ring LED lamps: 1-10

DIMMING: Dimmable using minimum 8 lamps and improves with larger load. Use low voltage electronic dimmers only

NOTES: Short Circuit Protection  
Constant voltage  
Class 2 power unit  
For LED lamps only

DIMENSION: 42mm (1.7") x 170mm (6.7") x 33mm (1.3")

DESIGNATION:



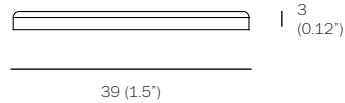
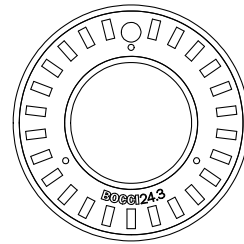
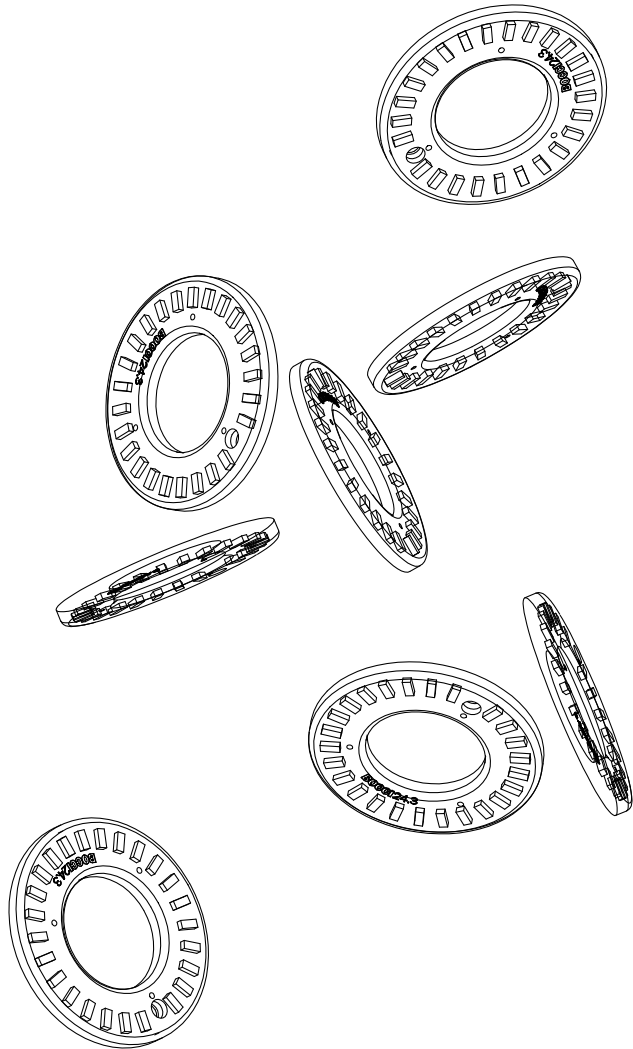

WATTAGE: 2.3w  
 COLOUR TEMPERATURE: 2400k  
 CRI: 75 (100 is daylight)  
 LIGHT OUTPUT: 190 lumens  
 EFFICIENCY: 83 lm/w  
 LAMP LIFE: 25,000 hours

#### DESCRIPTION

The 24.3 LED lamping option offers a longer-life, energy efficient alternative to typical halogen or xenon lamps. This proprietary and worldwide patent pending design utilizes a bipin snap connector that allows the lamp to be easily replaced.

This unique replacement design eliminates the waste associated with catastrophic failures that leave no choice but to replace the entire fixture. When it comes time to relamp with the Bocci lamp, the LED may simply be replaced. The Bocci LED lamp keeps the fixture out of landfills in the future, protects your investment and introduces a significant saving of energy.

#### NOTES

- + Purchase replacement lamps online at [www.bocci.ca/lamps](http://www.bocci.ca/lamps)
- + Compatible with 73 pendants only.

RoHS 

Vancouver  
[sales@bocci.ca](mailto:sales@bocci.ca)  
[www.bocci.ca](http://www.bocci.ca)

Berlin  
[europe@bocci.ca](mailto:europe@bocci.ca)  
[www.bocci.ca](http://www.bocci.ca)

LED

2.3W

Design by Omer Arbel  
 PRODUCT SPECIFICATION