

# 16

tree

Formed by sequentially pouring three separate puddles of molten glass of varying opacity and colour over a horizontal plane. Each layer responds to the indeterminate shape of the previous pour to create a layered whole. Two of these pieces are then attached to house an internal light source.



# 16

tree

## Lamping

1.8w LED

## Material

poured glass, electrical components, bead blasted stainless steel armature components

## Patent

US patent # D754,911  
EU patent #002672774 - 0001 to 0012



±216  
(8.5")

±203  
(8")

# 16

tree

## Tree System

16.10  
Olive

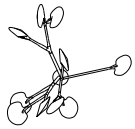

16.15  
Cypress

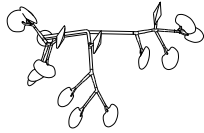

16.20  
Hawthorne

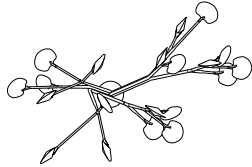

16.25  
Elm

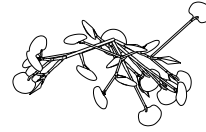

16.35  
Aspen

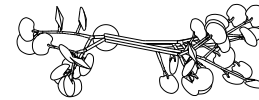

16.40  
Birch

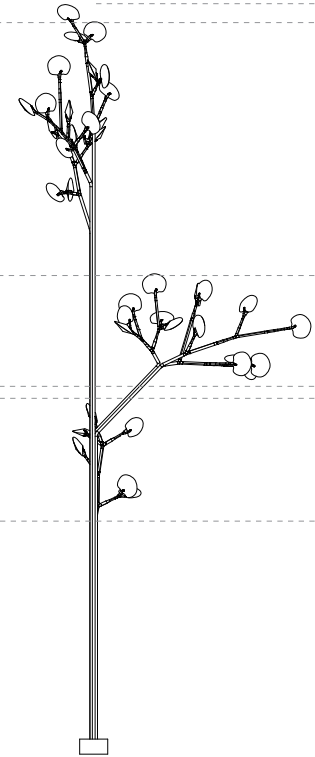
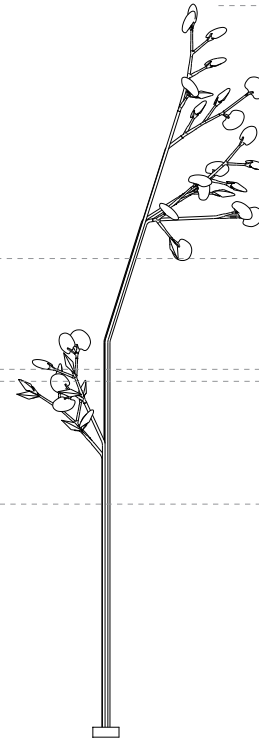
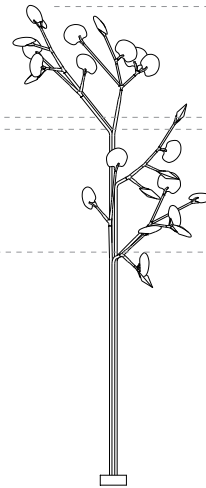
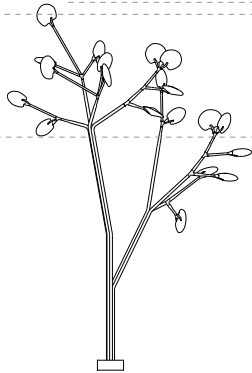
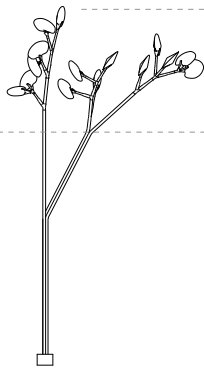
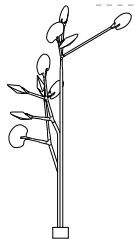

7100 (280")  
7000 (276")

3955 (156")

3500 (138")  
3400 (134")

2200 (87")

# 16

tree



# 16

tree



16  
tree



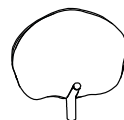
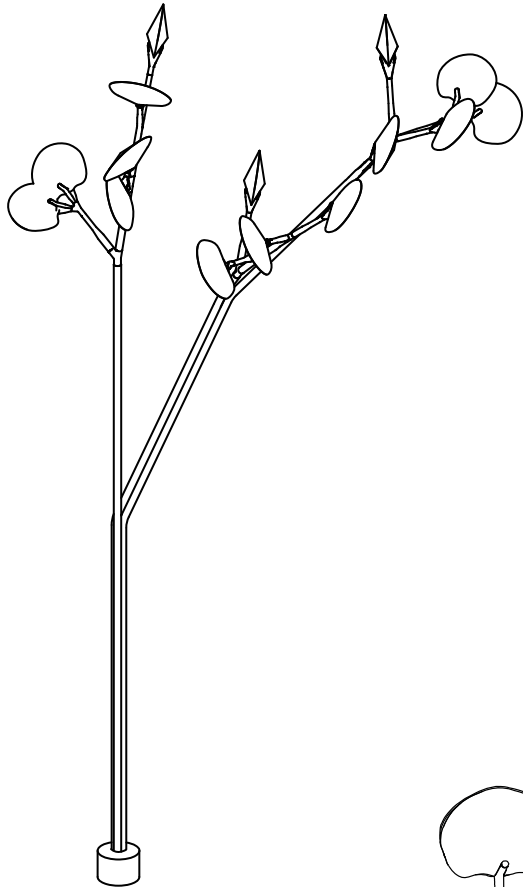

216  
(8.5')



64  
(2.5')

203 (8')

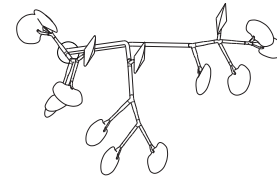

1200  
(47')

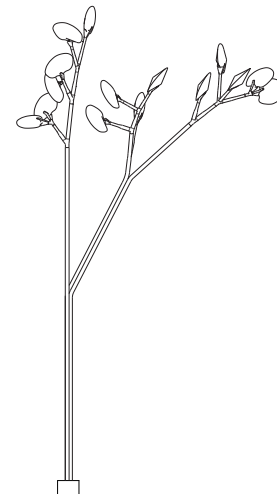

3400  
(134')

150 (6')

1950 (77')

- PENDANTS: fifteen
- MOUNTING: 150mm (6") diameter base plate
- LAMPING: 1.5w LED (22.5w total draw)
- DIMMING: not dimmable
- MATERIALS: poured glass, electrical components, bead blasted stainless steel armature components
- WEIGHT: approximately 93kg (205lb)
- TRANSFORMERS: remote

#### DESCRIPTION

The 16.15 is a tree-like 16 installation using fifteen pendants and a modular stainless steel armature system mounted to a three tube stainless steel 'cypress' base. These trees are designed to be grouped into forest-like assemblies of a variety of different sizes and types, but are strong compositional elements on their own. Installation of these trees is complex and Bocci recommends a structural consultant to assess the viability of the system in the context in which it is to be installed. Installation requires anchoring into either an existing structural slab or a newly built foundation to meet the specifications of the design drawings, including appropriate drainage if exposed to water and remotely mounted LED drivers.

16 is formed by sequentially pouring three separate layers of coloured, molten glass – in varying opacities – on a horizontal plane. Each layer responds to the indeterminate shape of the previous pour to create a uniquely layered whole. Two of these pieces are then attached and illuminated with an internal LED lamp. The finished 16 is visually complex: each separate colour layer is visible through the other layers, with light reflecting along the edges.

All trees are rated for outdoor (or indoor) use based on structural analysis for moderately sheltered locations near seawater with minimal snow loads. Any other application restraints may need further engineering.

#### NOTES

- + Purchase replacement lamps online at [www.bocci.ca/lamps](http://www.bocci.ca/lamps)
- + Available in a wet location configuration.
- + Transformers must be mounted remotely in an easily accessible and hidden location for ease of long-term maintenance.

US patent # D754,911  
EU patent #002672774 - 0001 to 0012

Made in Vancouver, Canada

Vancouver  
[sales@bocci.ca](mailto:sales@bocci.ca)  
[www.bocci.ca](http://www.bocci.ca)

Berlin  
[europe@bocci.ca](mailto:europe@bocci.ca)  
[www.bocci.ca](http://www.bocci.ca)

approx 93kg (205lb)

CYPRESS

# 16.15

Design by Omer Arbel  
PRODUCT SPECIFICATION

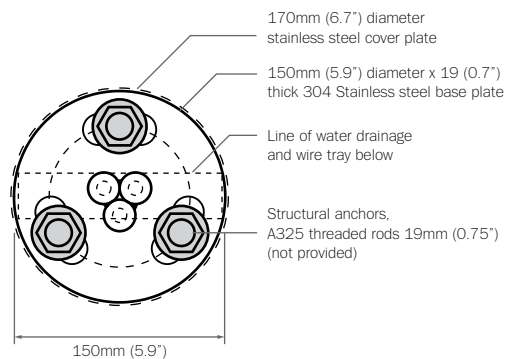

PENDANTS: DL: 23N (5.3lbs)

MAX UNFACTORED WIND SPEED: 21 m/s

MAX UNFACTORED SNOW /  
ICE LOAD: 6 N /pendant

UNFACTORED SEISMIC LOAD: 535N HORIZONTAL @ 2500mm ABOVE BASE CONNECTION

FACTORED DESIGN LOAD FOR  
BASE CONNECTION: Mf: 2 kN\*m Vf: 1 kN

#### LOAD SUMMARY & DESIGN CRITERIA

Installation of these trees is complex and Bocci recommends a structural consultant to assess the viability of the system in the context in which it is to be installed. Installation requires anchoring into either an existing structural slab or a newly built foundation to meet the specifications of the design drawings, including appropriate drainage if exposed to water and remotely mounted LED drivers.

Anchoring of these trees is critical and it is imperative that the assembly drawings are followed. The foundation and fixing of anchors to the foundation are the responsibility of the client. Drawings are provided only to give a general idea of what is involved in installation for early phase design development. The trees are designed for the load assumptions above and should not be installed in a location where any of those design forces will be surpassed. Neglecting the design forces may lead to failure of the structure. The design of a suitable foundation is to be provided by a structural engineer.

The modular trees will deflect under wind loading. All modular tree components should be kept at least 600mm (23.6") away from any other object to allow space for the tree to deflect without causing damage to other objects.

For our purposes, and due to specific site constraints that will guide the preparation of the site, the installation instructions begin with the anchors already installed.

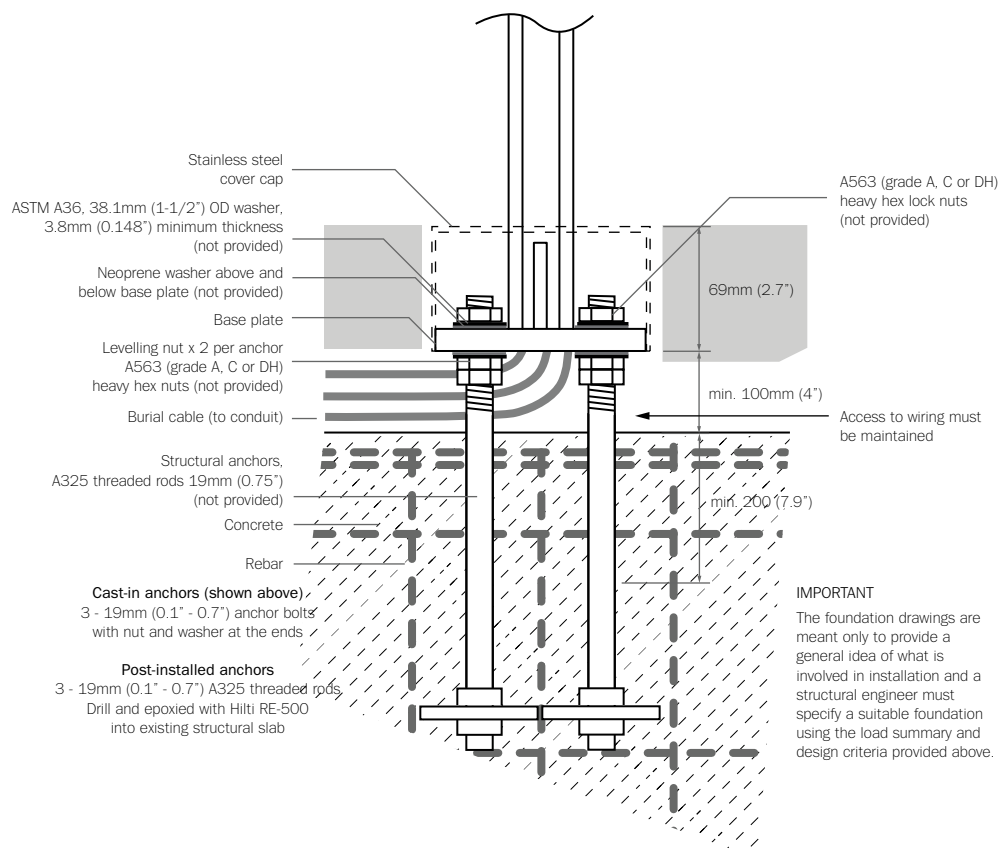

CYPRESS

# 16.15

Design by Omer Arbel  
PRODUCT INSTALLATION INSTRUCTIONS

© 2017, Bocci Design and Manufacturing Inc. All rights reserved. Any inquiries should be directed to: info@bocci.ca

# BOCCI



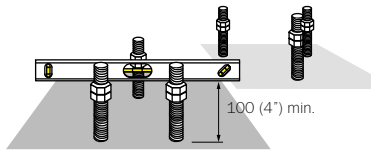

1

With the anchors in place, spin two of the provided nuts followed by a washer onto each anchor. Ensuring a minimum of 100mm (4") from top of leveling nuts to ground, use a level and level off 4 sets of nuts (hardware not provided).

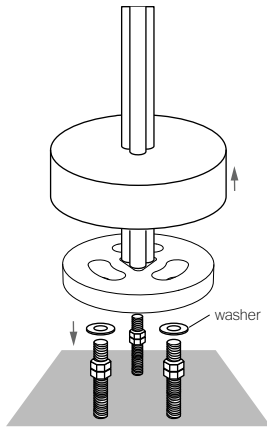

2

Place washer on each anchor.  
Lift off the cover.

Using heavy equipment (if necessary), lower the tree base onto the anchor keeping the pull wire free for the following steps. Repeat this step for all nearby trees.

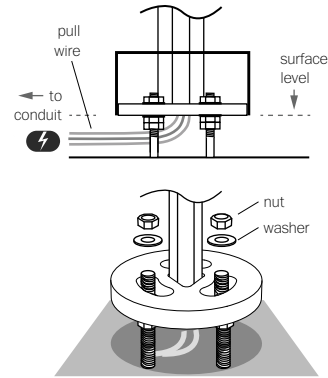

3

Orient the tree base in the direction you want the branches to go.

Once all tree bases are in place, put another washer on each anchor followed by a nut and tighten the nuts until snug.

Note: Make sure that the area under the base is kept clear and the pull wire does not get damaged during install.

Do not in-fill this area under the base. Wires must be kept free, even after final install.

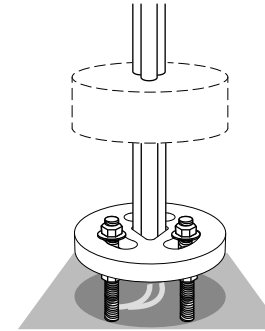

4

Once all wiring connections are complete, and the nuts are snug-tight, slide the cover cap down over the plate until it rests on either the gussets or the ground.

Note: Bocci recommends installing the finish floor height higher than the cover cap with a small reveal around the tree base or alternately installing flush with the cover plate.

Depending on the final installation aesthetic, you may want to finish the floor at this point if the finished floor can support a lift or scaffold for installation of the pendants. If not, complete steps 6-8 before finishing the mount detail.

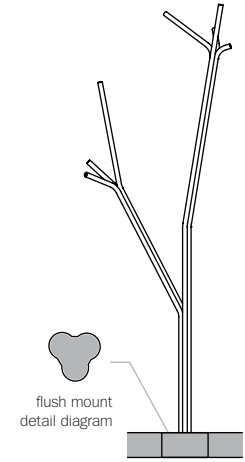

5

You should now have an upright tree base ready for composition of the pendants according to the specification sheet.

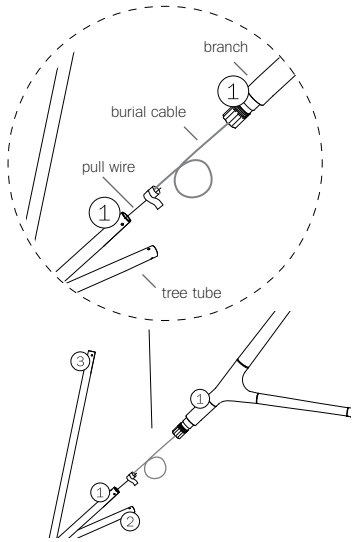

6

Matching the branch number with the tree tube number, secure the burial cable of each branch to the end of the pull wire with tape or other temporary means.

Ensure burial cable still fits freely through the tree tube.

Note: Test each branch to ensure all LEDs light before attaching to tree.

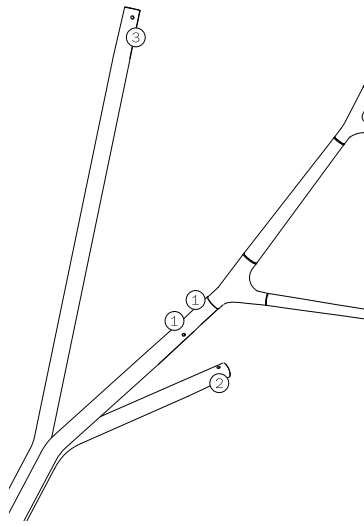

7

Orient branches as desired, ensuring there is no interference with adjacent branches, pendants or trees.

Tighten set screws to secure the branch.

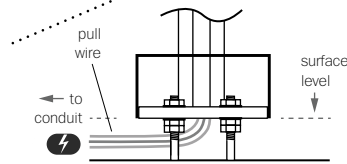
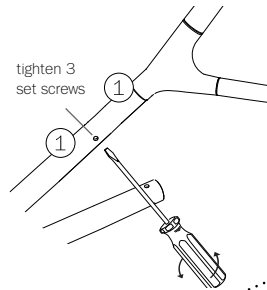

8

Once all branches are installed, feed pull wires through pre-laid conduit to the driver (power supply) location.

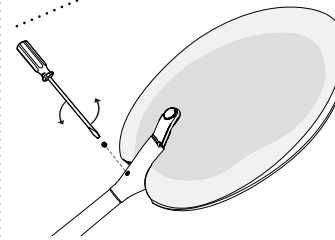
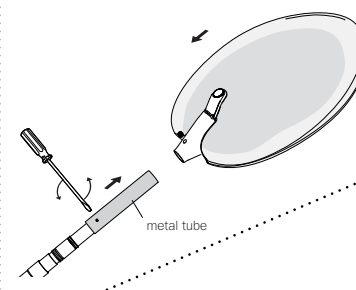

9

Remove the metal tube at the end of each branch by unscrewing the set screw.

Slide the pendant onto the branch, orient as desired, and secure using an M3 set screw (provided).

Note: If the fixture sags or seems unbalanced you may be overloading the base. Remove pendants, or shorten cantilever as required.

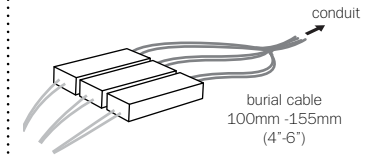

10

Connect burial cables to drivers (power supplies), ensuring to leave 100-155mm (4'-6") of loose excess burial cable.

Clean fingerprints from pendants.

Turn fixture on.

For additional assistance, please contact Bocci:

Vancouver  
sales@bocci.ca  
www.bocci.ca

Berlin  
europe@bocci.ca  
www.bocci.ca

US patent # D754,911  
EU patent # 002672774-0001 to 0002

Made in Vancouver, Canada

CYPRESS

16.15

Design by Omer Arbel  
PRODUCT INSTALLATION INSTRUCTIONS

© 2017, Bocci Design and Manufacturing Inc. All rights reserved. Any inquiries should be directed to: info@bocci.ca

**BOCCI**

## 120/240V LED Driver - 40W

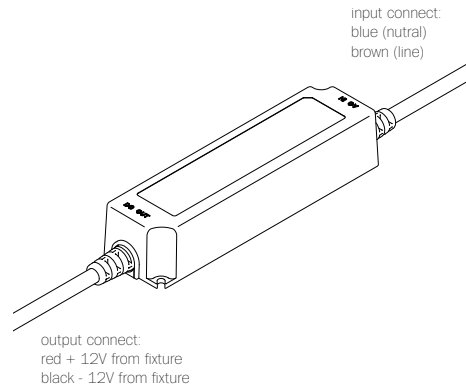

### MW-LPF-40-12

PRIMARY: AC 100 - 240V, 800mA, 50/60Hz  
AC 277V, 320mA, 50/60Hz

SECONDARY: Max. 12V DC (40w max.)

LAMPING: 16.10 Olive  
16.15 Cypress  
16.20 Hawthorne  
16.25 Elm  
73.10 Olive  
73.15 Cypress

DIMMING: Non-dimmable

NOTES: IP67 rating (suitable for wet locations)  
Short Circuit Protection  
Constant voltage  
Class 2 power unit  
For LED lamps only

DIMENSION: 43mm (1.7") x 163mm (6.4") x 32mm (1.3")

DESIGNATION:   IP67  
E124867

 SELV-equivalent

  
ta: 50°C  
tc: 80°C

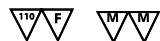

## 120/240V LED Driver - 60W

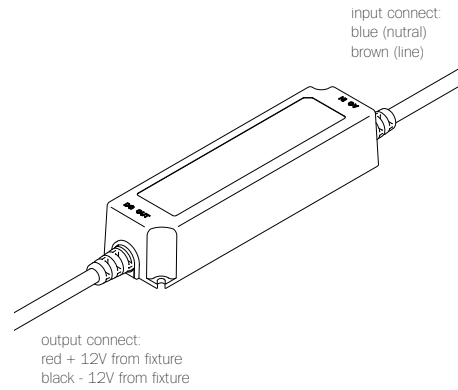

### MW-LPF-60-12

PRIMARY: AC 100 - 240V, 800mA, 50/60Hz  
AC 277V, 320mA, 50/60Hz

SECONDARY: Max. 12V DC (60w max.)

LAMPING: 16.35 Aspen  
16.40 Birch  
73.20 Hawthorne  
73.25 Elm  
73.35 Aspen  
73.40 Birch

DIMMING: Non-dimmable

NOTES: IP67 rating (suitable for wet locations)  
Short Circuit Protection  
Constant voltage  
Class 2 power unit  
For LED lamps only

DIMENSION: 43mm (1.7") x 163mm (6.4") x 32mm (1.3")

DESIGNATION:   IP67  
E124867

 SELV-equivalent

  
ta: 50°C  
tc: 80°C



LED

# Drivers

PRODUCT SPECIFICATION

For additional  
assistance, please  
contact Bocci:

Vancouver  
sales@bocci.ca  
www.bocci.ca

Berlin  
europe@bocci.ca  
www.bocci.ca

© 2018, Bocci Design and Manufacturing Inc. All rights reserved. Any inquiries should be directed to: info@bocci.ca

# BOCCI

LED

# 1.8W

Design by Omer Arbel  
PRODUCT SPECIFICATION

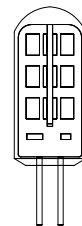
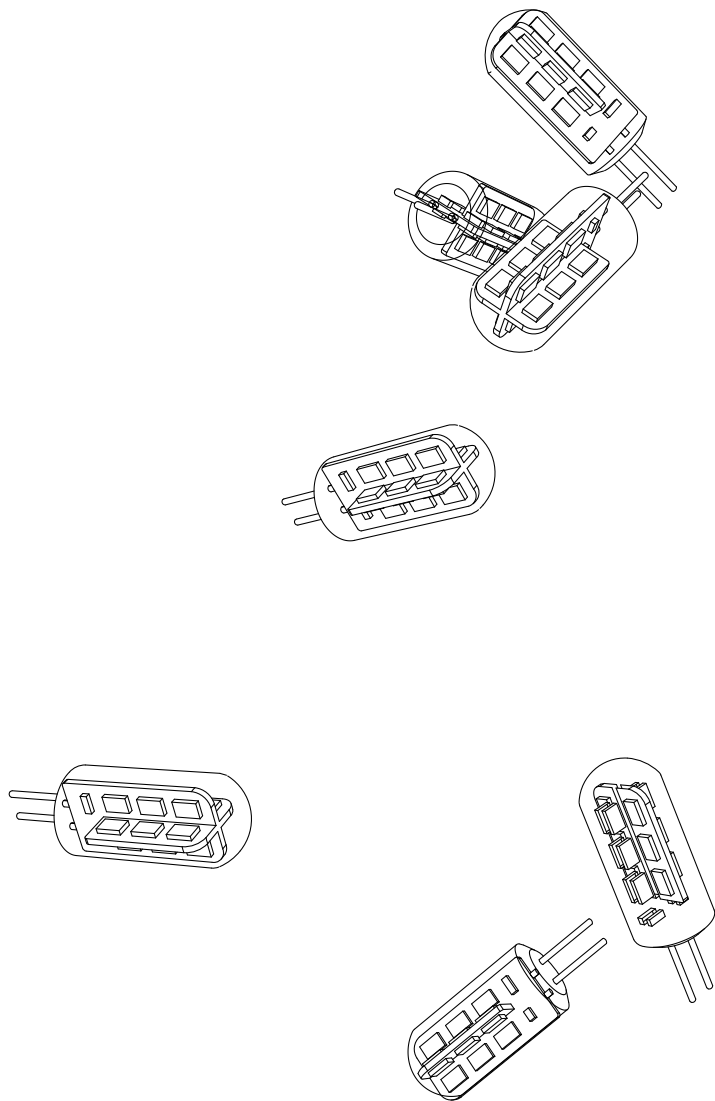

38 (1.5")



12.5 (0.5")

WATTAGE: 1.8w  
 COLOUR TEMPERATURE: 2600k  
 CRI: 75 (100 is daylight)  
 LIGHT OUTPUT: 142 lumens  
 EFFICIENCY: 60 lm/w  
 LAMP LIFE: 25,000 hours

### DESCRIPTION

The Bocci 1.8w LED lamping option offers a longer-life, energy efficient alternative to typical halogen or xenon lamps. This proprietary and worldwide patent pending design utilizes Bocci's standard G4 lamp holder (9.1mm/0.36" in diameter), which is designed to accept either the Bocci xenon lamp or the Bocci LED lamp. The possibility of dual usage allows the opportunity for existing chandeliers with xenon lamping to be retrofitted on site to LED along with the appropriate driver.

This unique replacement design is unlike typical embedded xenon fixtures as it eliminates the waste associated with catastrophic failures that leave no choice but to replace the entire fixture. When it comes time to relamp, the xenon heads may simply be replaced, as with conventional lamps. Bocci xenon lamp keeps the fixture out of landfills in the future, protects your investment and introduces a significant saving of energy.

### NOTES

+ Purchase replacement lamps online at [www.bocci.ca/lamps](http://www.bocci.ca/lamps)

RoHS 

Vancouver  
[sales@bocci.ca](mailto:sales@bocci.ca)  
[www.bocci.ca](http://www.bocci.ca)

Berlin  
[europe@bocci.ca](mailto:europe@bocci.ca)  
[www.bocci.ca](http://www.bocci.ca)