

MILE 04

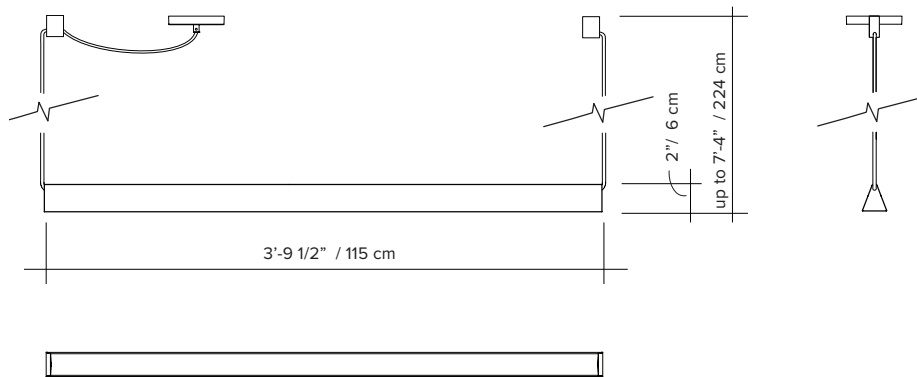

type:	suspension
materials:	body: powder coated aluminum lens: frosted polycarbonate hardware: powder coated aluminum wire: polyester
wire length:	108" live wire feed 84" unloaded wire
weight:	115cm 3.7 lb / 1.7 kg
light source:	68W (see lightbulb section for specifications)
voltage:	120V / 240V
dimmer:	refer to our recommended list of dimmer models
certifications:	

- notes:**
- must be installed by an electrician
 - additional charges for modifications or for special orders
 - dimensions are approximate and may vary slightly
 - lead time 12 weeks



ORDER GUIDE: SKU

COLLECTION		MODEL	COLOUR (frame/wire/anchor)		COLOUR (canopy)		MOUNTING TYPE	
Mile	mile	04	BL	black	WH	white	SM	single mounting * Row mounting available
			BU	burgundy				
			BG	beige				
			GN	green				
MIL		04	BL		WH		SM	= MIL04BLWHSM example

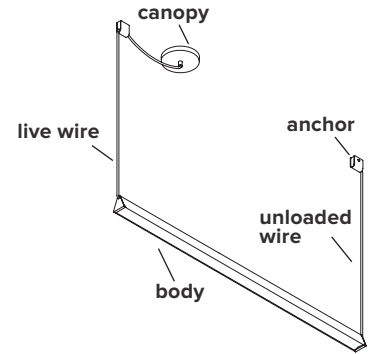

COLOUR (frame, wires and anchors)

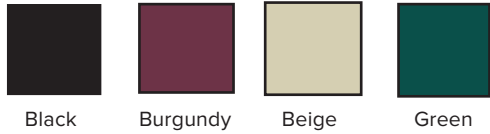

COLOUR (canopy)



MOUNTING TYPE

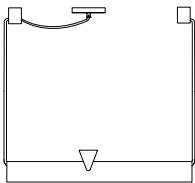

Single mounting

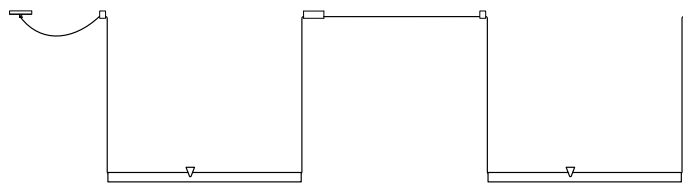

Row mounting available
(please consult sales team)

ANCHORS

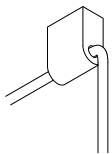

Regular anchor

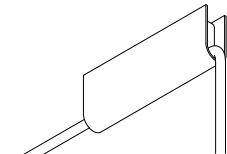

Connecting anchor
for row mounting

LIGHT BULB & DIMMER SPECIFICATIONS

AC LED BOARD

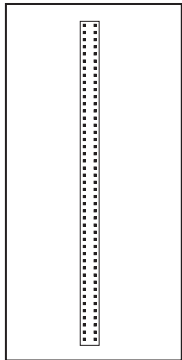

68 W
 100V-120V / 240V
 downlight 2860 lumens
 LED 2700K
 50 000 H
 CRI ≥90
 2 years warranty
 3 SDCM consistency

DIMMER LIST COMPATIBILITY – 120V

The dimming technology offering the best results is ELV (electronic low voltage) dimmers with reverse phase or trailing edge control.

<u>DIMMER BRAND</u>	<u>MODEL NUMBER</u>	<u>MAX LEVEL</u>	<u>MIN LEVEL</u>	<u>FLICKERING</u>	<u>OVERALL QUOTE</u>
LUTRON - MAESTRO	MAELV-600	100%	10%	0%-10%	good
LUTRON - SKYLARK	SELV-300P	100%	10%	no	very good
LUTRON - SKYLARK	SELV-303P	100%	10%	no	very good
LUTRON - SKYLARK	CTELV-303P	100%	10%	no	very good
LUTRON - DIVA	DVELV-300P	100%	10%	no	very good
LEGRAND - ADORNE	TRUE UNIVERSAL	100%	30%	no	good

*Other dimmers can yield good results and we recommend conducting your own test before final installation.

ENTRETIEN / MAINTENANCE

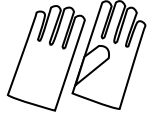

When handling your light fixture, please use enclosed cotton gloves to avoid blemishes

Unfinished Brass

If your lamp contains brass components, its look will evolve over time. We work with unfinished brass because we believe brass looks best when it is allowed to build a patina with age.

If you want to restore the lamp's original polished finish, please follow instructions for metal polish.

Instructions for use of metal polish (e.g. Collinite No.850 Metal Wax)

1. Shake product well before application.
2. Using a thin applicator pad, apply a thin amount of metal polish to small sections at a time.
3. Rub well locally to loosen the tarnish.
4. Reapply as necessary until surface is free of contaminants.
5. Before product dries, polish with a dry, clean, and soft microfiber cloth towel.

WARNING : The above instructions apply to brass components only.

Painted Surface or Graphite Finish

If your light fixture contains painted surfaces or a graphite finish, it can be cleaned using any all purpose household cleaner. Do not use solvents containing strong chemicals.

Pour manipuler la lampe, svp utiliser les gants de coton fournis dans la boîte.

Le Laiton brut

Si votre luminaire comporte des pièces en laiton, sa couleur changera. Ceci n'est pas un défaut de fabrication, mais bien le changement normal de l'apparence du laiton avec le temps. Nous avons choisi comme matière première le laiton brut car nous croyons que le laiton est à son meilleur quand il développe une patine avec l'âge.

Si vous désirez redonner une apparence neuve - polie – à votre luminaire, svp suivre les instructions pour le polissage.

Instructions pour l'utilisation de la crème de polissage (ex. Collinite No.850 Metal Wax)

1. Bien agiter le produit avant l'utilisation.
2. À l'aide d'un chamois ou chiffon doux de coton, verser une fine couche de crème, une section à la fois.
3. Frotter la surface doucement sur les traces foncées du métal terni.
4. Repasser avec la crème de polissage jusqu'à ce qu'il n'y ait plus de traces indésirables.
5. Avant que le produit ne sèche, essuyer la surface avec un chiffon en microfibres sec et propre.

ATTENTION : Les instructions ci-dessus, ne s'appliquent qu'aux pièces en laiton.

Surfaces Peintes et Fini Graphite

Si votre luminaire contient des surfaces peintes ou un fini graphite, utiliser n'importe quel produit nettoyant multi-usages standard et un chiffon doux. Éviter tous solvants contenant des produits chimiques forts.